

CTCII
CONDUCTIVITY/TDS
Chemical Treatment Controller
(Cooling Tower Controller)
Operation
Manual

14 JANUARY 05

INSTALLATION • OPERATION • MAINTENANCE

Controller Only: CTCII, & CTCIIT
Monitor/controller: CTCIID, & CTCIITD

ACCURACY • RELIABILITY • SIMPLICITY

MYRON L
COMPANY
Water Quality Instrumentation
Accuracy • Reliability • Simplicity

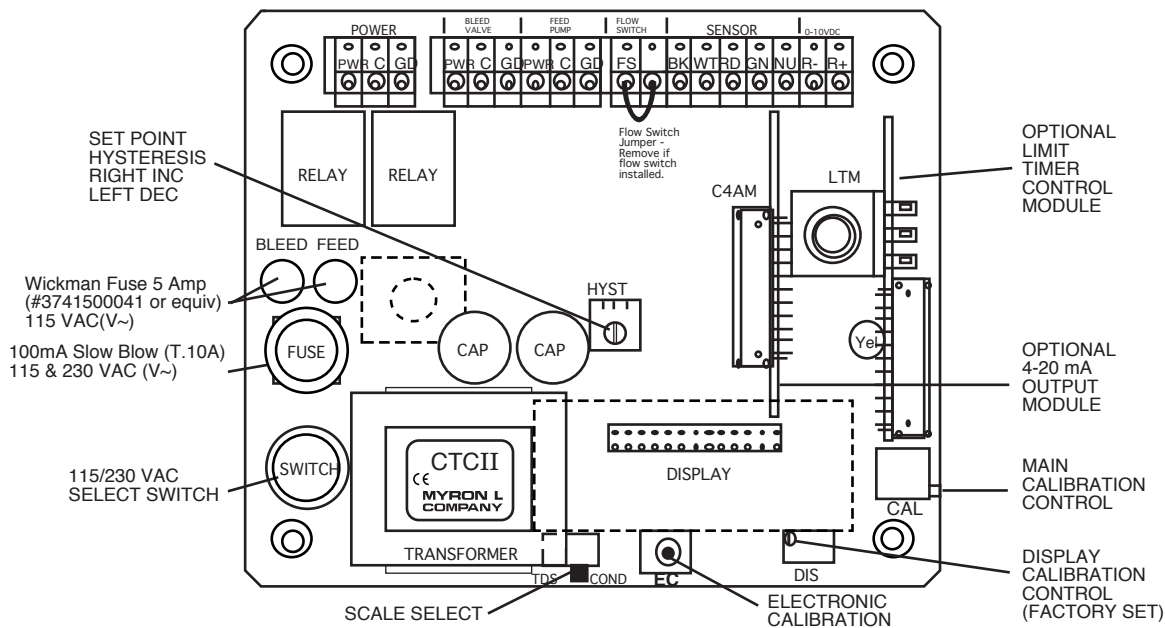

CTCII MAIN CIRCUIT BOARD

Figure V.A.1

**ELECTRONIC CALIBRATION (CIRCUIT ONLY) -
See Section V.B.1.**

a. Set Point Control Calibration

1. Ensure power is **OFF**.
2. Using a standard slot screwdriver remove the four (4) screws on the clear cover and remove cover.
3. The front panel is held in place with hook & loop strips on each side. By carefully lifting at the slot on the top, the front panel will pull toward you. Do not pull more than about 8 inches/20CM.
DO NOT pull on control knob(s).
4. Rotate the front panel down so that the back side is facing you. The Circuit Board is mounted to the back of the front panel.
5. Turn power **ON**.

Caution: When handling CB, DO NOT touch component side. Electrical shock may occur.

6. Press and hold the EC switch.
7. Rotate Set Point control from "0" toward EC. At EC the relay should click, and the LED should change from RED to GREEN. If not, set Set Point control to EC and adjust the CALibration control.
Models with 3 1/2 digit LCD.
The display should indicate 2.50.
If not, adjust the DISplay calibration control.
8. Turn power OFF.
9. Re-install front panel and cover as described in "REASSEMBLY".
10. To operate, turn power ON.

**b. 0-10VDC Recorder Output Calibration
See section V.B.1.**

USING STANDARD SOLUTIONS - Section V.B.2.

The **BEST** method of verifying and recalibrating your CTCII Chemical Treatment Controller is with NIST traceable Standard Solution (available from the Myron L Company). Because it includes the sensor, the entire system is calibrated.

The following procedure describes the easiest method for standard solution calibration. We recommended using Myron L 442-3000 Standard Solution or equivalent. This standard solution will calibrate either Conductivity μS (at 3900 μS) or TDS ppm (at 3000 ppm).

1. Rinse thoroughly, and fill a clean glass beaker with standard solution.
2. Place sensor in beaker of standard solution. The level of standard solution must be high enough to cover at least 1/2" above the electrodes.
3. Slowly shake the sensor to remove air bubbles from the electrodes.
4. Allow 5-10 minutes for temperature to equilibrate. For the quickest and the best results, both the sensor and solution should be at the same temperature.
5. Turn power **ON**.
6. Rotated the Set Point control to 3900 for Conductivity models or 3000 for TDS models. The relay should click and the LED will change from GREEN to RED. If the set point is different, adjust **CAL**ibration control on the main circuit board until the reading matches the solution.
Models with display (standard 3 1/2 digit).
The display should match the value of the standard solution, 3900 μS (displayed as 3.90) or 3000 ppm (displayed as 3.00).
If the reading is different, adjust **DIS**play calibration control on the main circuit board until the reading matches the solution.
7. After adjustment, turn power **OFF**.
8. Re-install front panel and cover as described below in "REASSEMBLY".
9. To operate, turn power **ON**.

TRANSFER STANDARD METHOD - See Section V.B.3.

CTCII

CHEMICAL TREATMENT CONTROLLER (COOLING TOWER CONTROLLER)

QUICK REFERENCE GUIDE!

If you read nothing else in this manual please read this Quick Reference Guide.

PLEASE READ and COMPREHEND ALL WARNINGS, CAUTIONS and ADVISEMENTS CONTAINED WITHIN THIS MANUAL.

Failure to comply is beyond the responsibility of the Myron L Company.

WARNING: ALL CONTROLLERS ARE FACTORY SET TO OPERATE ON 115 VAC. BEFORE APPLYING POWER ENSURE THE INPUT POWER "115/230 VAC" SELECTION IS CORRECT FOR YOUR REQUIREMENTS. FAILURE TO DO SO IS BEYOND THE RESPONSIBILITY OF THE MYRON L COMPANY. See section II.D.1. and figure II.E.1.

WARNING: ENSURE POWER IS OFF WHILE INSTALLING ELECTRICAL EQUIPMENT. IF MONITOR/CONTROLLER IS INSTALLED, ENSURE THE POWER IS OFF BEFORE SERVICING. FAILURE TO DO SO COULD CAUSE DAMAGE TO THE INSTRUMENT, AND COULD BE HARMFUL OR FATAL TO PERSONNEL. ONLY QUALIFIED PERSONNEL SHOULD INSTALL OR SERVICE ELECTRICAL EQUIPMENT.

CAUTIONS: Before installation, ensure you have the correct model (with options), AND it is scaled for your application. See sections I.A. & I.B.

Do you have the correct sensor? See section I.E. Mounting requirements. What is needed? See section II.B.

The following will give the installer and user a quick overview. See the sections listed for details.

REMOVING FRONT PANEL

1. Using a Phillips Head screwdriver remove the four (4) screws on the clear cover.
2. Remove clear cover.
3. The front panel is held in place with hook & loop strips on each side. By carefully lifting at the slot on the top, the front panel will pull toward you. Do not pull more than about 8 inches/20CM.
DO NOT pull on control knob(s).
4. Rotate the front panel down so that the back side is facing you. The Main Circuit Board is mounted to the back of the front panel.

REASSEMBLY

1. Carefully reinstall the front panel.
2. Reinstall the clear cover.
3. Reinstall the four (4) screws and tighten.

4. If desired, install corner covers.
5. To operate, turn power **ON**.

INTRODUCTION - Section I.

This section covers the specifications of your new CTCII Chemical Treatment Controller including sensor information.

INSTALLATION - Section II.

This section covers how to install your new CTCII Chemical Treatment Controller; mechanically and electrically.

OPTIONS & ACCESSORIES - Section III.

This section covers the specifications, installation, set up, and operation of each option.

OPERATING PROCEDURES - Section IV.

This section covers a brief description of different models and their features; how they work, and how to set them up for your particular use.

QUICK CHECK-OUT PROCEDURE -

See Section IV.B.1.

It is assumed that the Controller power is ON, that it is connected to an appropriate sensor, and that the sensor is immersed in water within the range that the Controller will be required to operate, and the clear lid is removed from the Controller.

1. Rotate the large Set Point Control knob on the front panel through its entire range.
2. Verify that the set point indicator light changes from RED to GREEN and visa versa.
3. Verify that the relay clicks, and controls the bleed valve and/or chemical feed pump.
4. Adjust the set point control to the desired set point value.
5. Re-install clear cover.

HYSTERESIS (DEAD BAND) ADJUSTMENT -

See Section IV.B.3.

PRIMARY COMPONENT IDENTIFICATION -

Section V.A.

Review the figure on the following page to familiarize yourself with the Main circuit board assembly. The diagram shows the Limit Timer and the optional 4-20 mA Output module installed.

QUICK CALIBRATION - Section V.B.

WARNING: When performing calibration procedures, the technician must take extreme care to avoid contacting the circuitry other than the CALibration control. Failure to do so could result in damage to the equipment, property and/or personal injury.

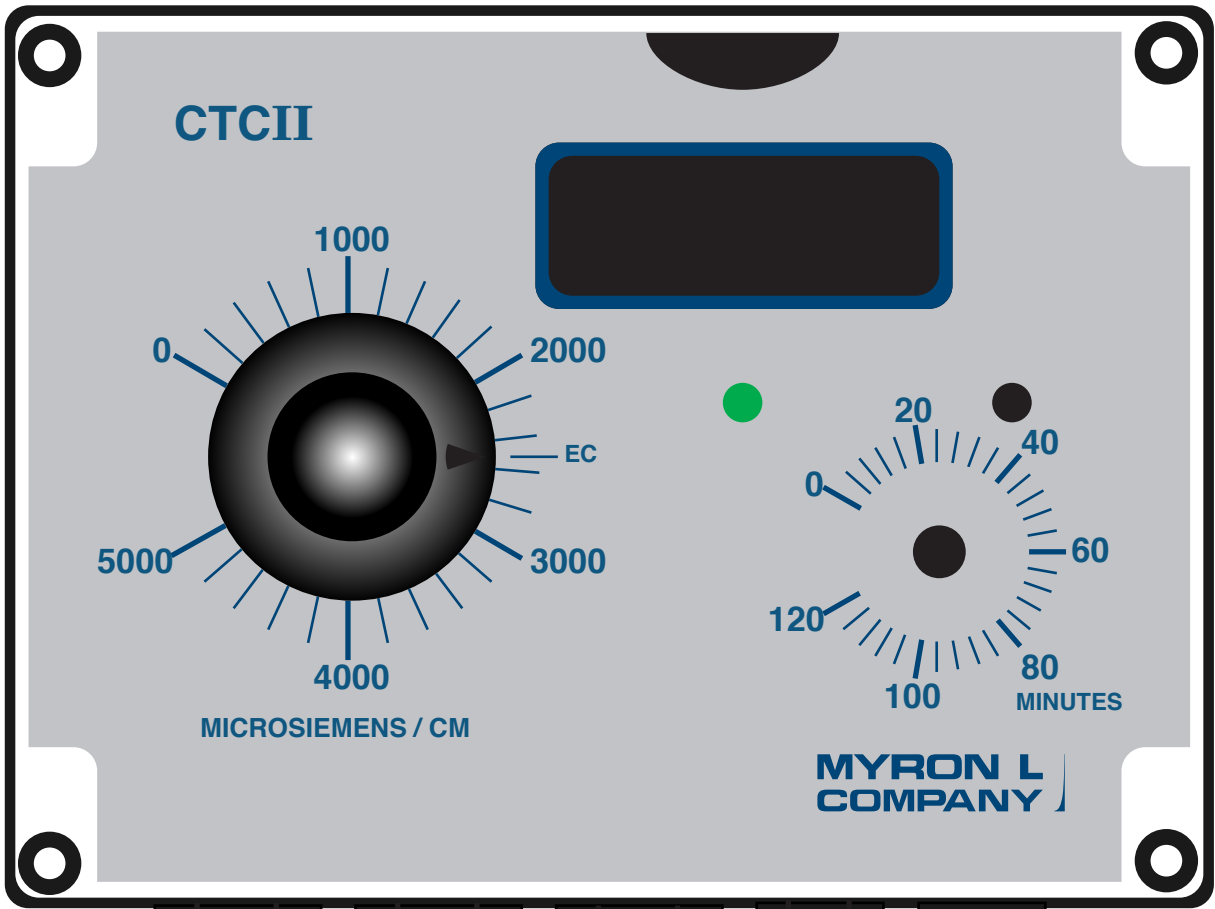

**CTCII
Basic
Model**

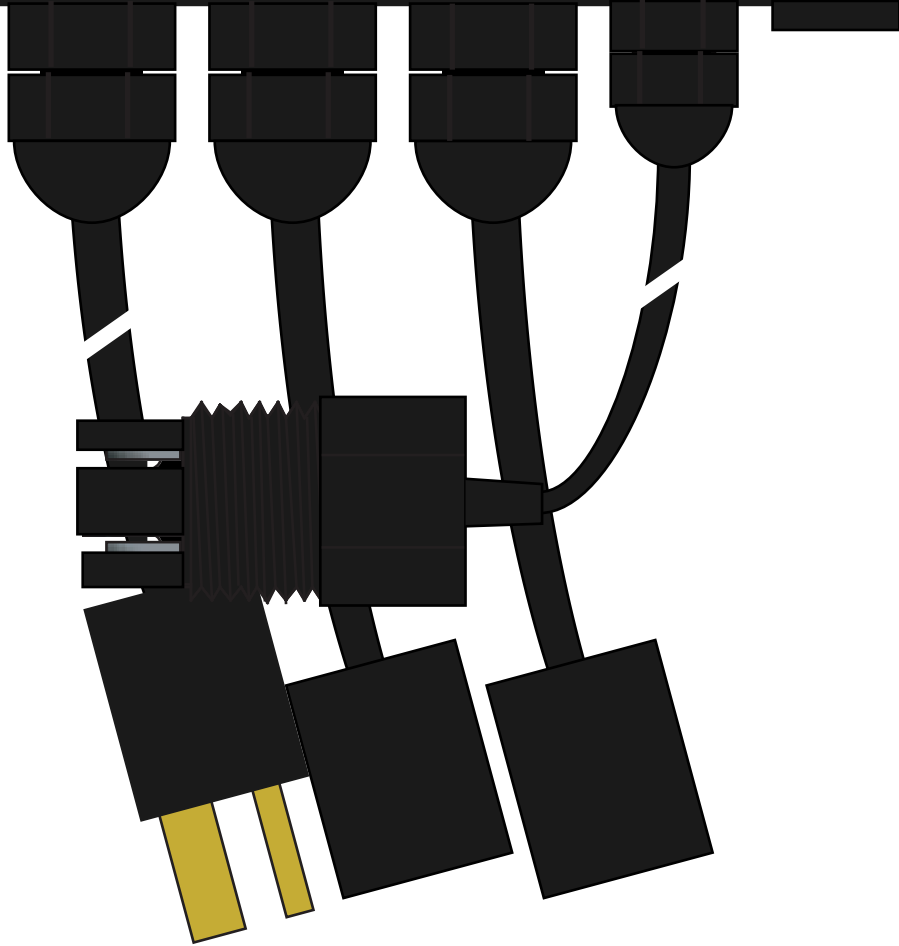

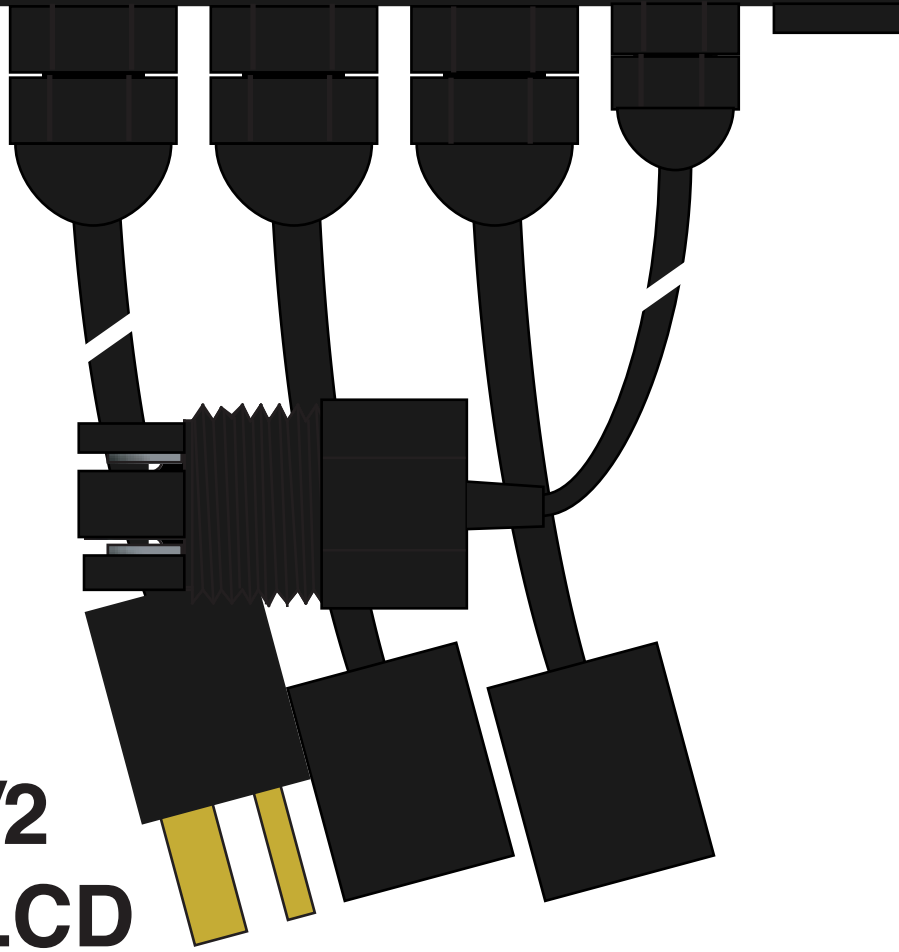

CTCII
w/ 3 1/2
Digit LCD

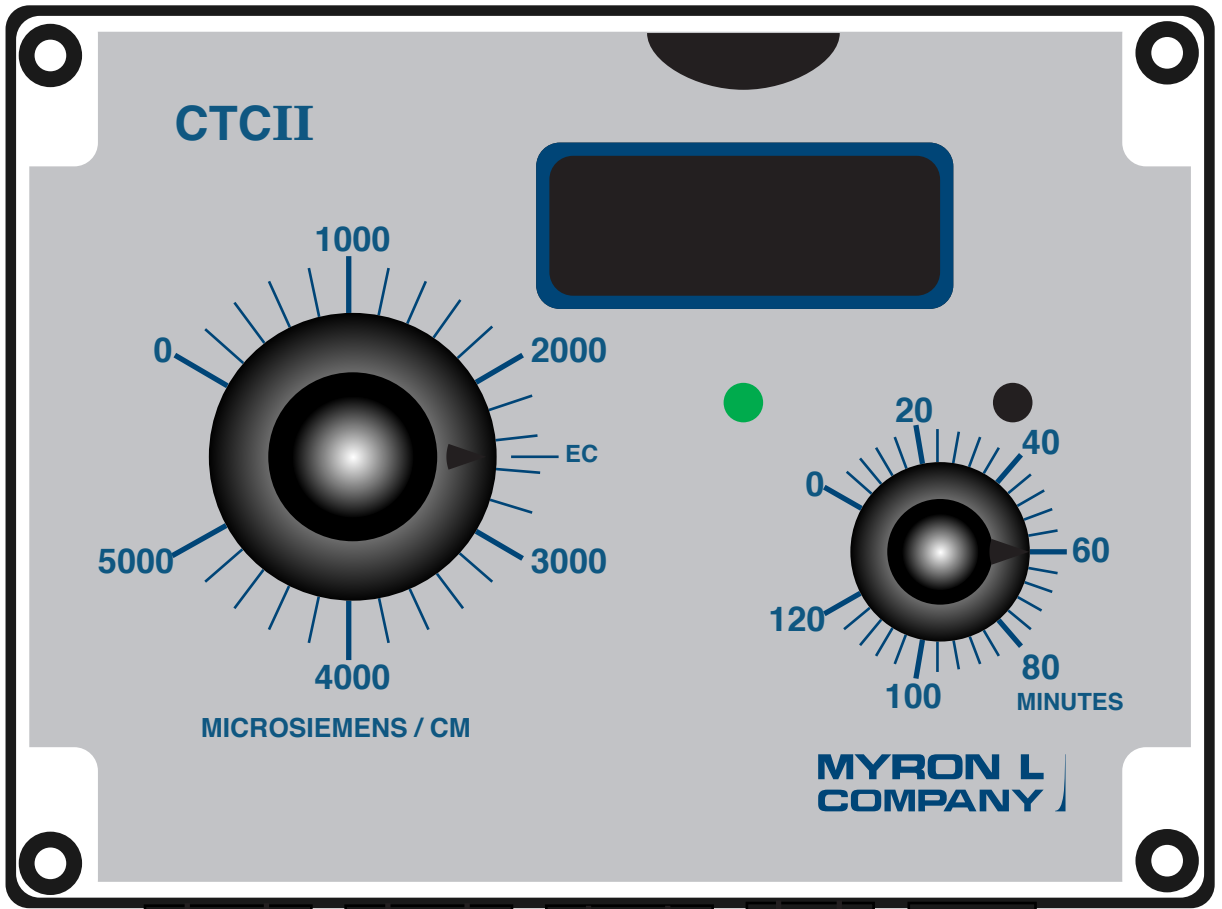

**CTCII w/
Feed Pump
Limit Timer**

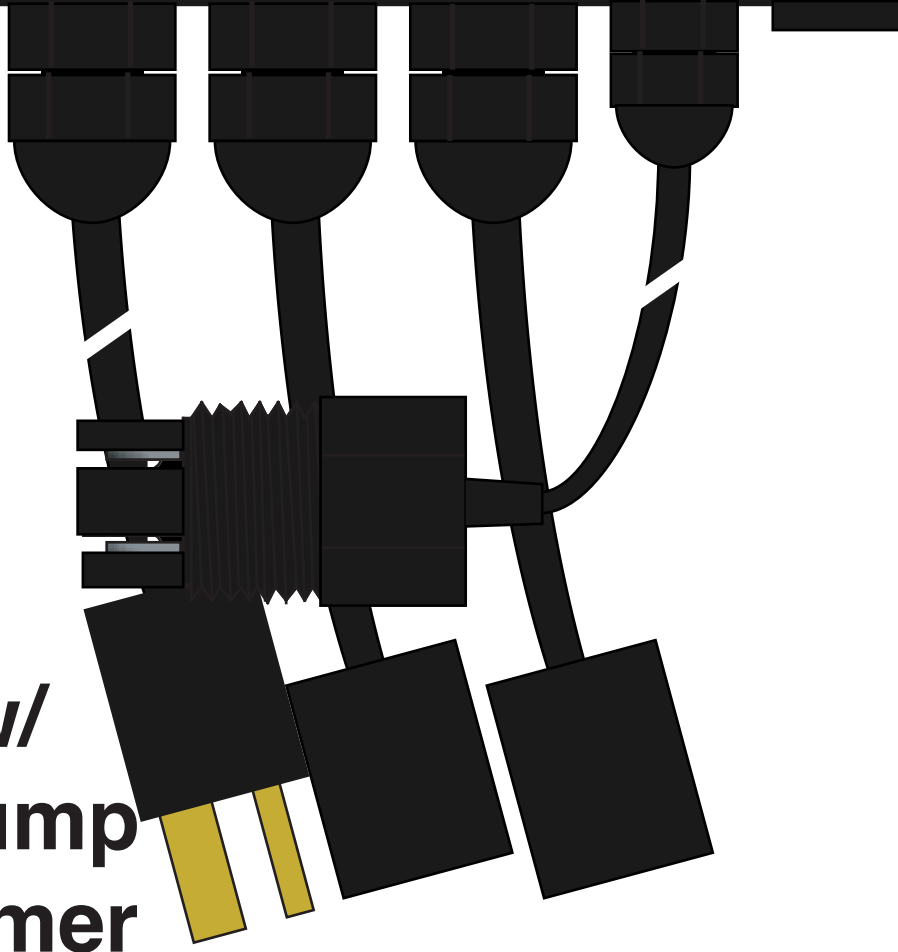

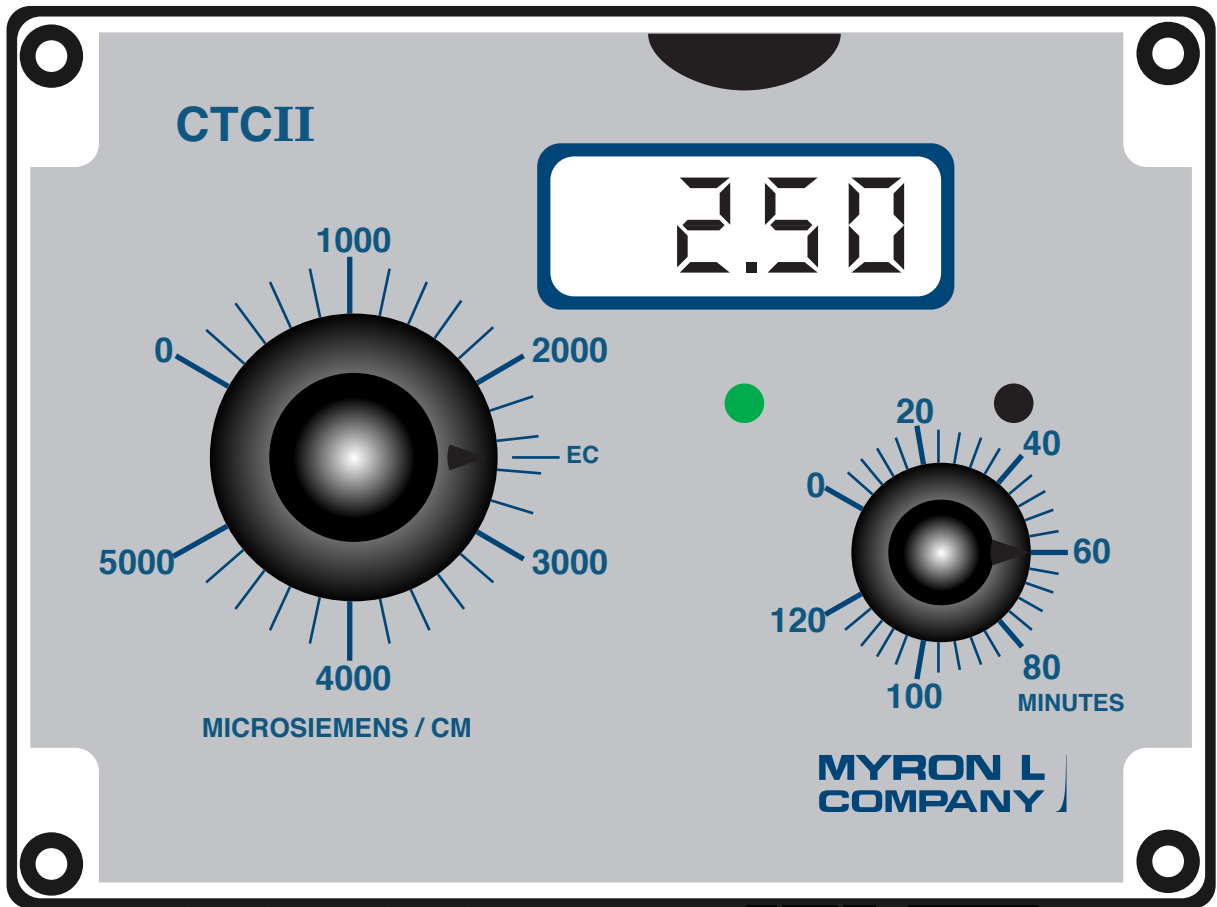

**CTCII
w/ 3 1/2
Digit LCD
Feed Pump Limit Timer**

TABLE OF CONTENTS

SECTION	PAGE
CTC Series II ILLUSTRATIONS (CTCII, CTCIID, CTCIIT & CTCIITD)	1-4
I. INTRODUCTION	7
A. SCOPE.....	7
1. Functional Descriptions	7
2. Applications.....	7
B. SPECIFICATIONS	7
C. OPTIONAL FEATURES.....	8
D. ACCESSORIES.....	8
E. SENSORS.....	9
1. Conductivity/TDS	9
2. Sensor Specifications	9
F. ORDER INFORMATION.....	9
1. How to order a CTCII controller	9
2. How to order Sensors	9
II. INSTALLATION	10
A. GENERAL.....	10
B. MECHANICAL INSTALLATION	10
1. Surface Mounting.....	10
C. SENSOR INSERTION / DIP MOUNT ASSEMBLIES	11
1. CSAR Insertion Mode Assembly.....	11
2. CS51R Alternate Dip Sensor Assembly.....	11
D. ELECTRICAL INSTALLATION.....	11
1. 115/230 VAC Conversion	11
2. Connecting the Sensor Cable	12
a. Modification for US Pharmaceutical 25 (No Temperature Compensation)	12
3. Flow Switch.....	12
E. 0-10 VDC OUTPUT	13
1. Connection.....	13
2. Voltage Divider.....	13
F. RESCALE	14
III. OPTIONS & ACCESSORIES INSTALLATION	15
A. -LTM (LIMIT TIMER MODULE)	15
1. Description	15
2. Installation.....	15
a. Hysteresis.....	15
B. -C4A MODULE (4-20mA OPTION)	15
1. Description	15
2. Installation.....	16
3. Recalibration	17
IV. OPERATING PROCEDURES	18
A. FRONT PANEL INDICATORS & CONTROLS	18
1. Red LED Indicator	18
2. Green LED Indicator	18
3. Set Point Control.....	18
4. Digital Display Models.....	18
5. Limit Timer Models.....	18
B. SETUP PROCEDURES	19
1. Check-Out Procedure	19
2. Set Point Adjustment	19
3. Hysteresis (Dead Band) Adjustment.....	19
4. Feed Pump Limit Timer.....	19
V. COMPONENT IDENTIFICATION, CALIBRATION AND PREVENTIVE CARE	20
A. PRIMARY COMPONENT IDENTIFICATION	20
B. CALIBRATION PROCEDURES - MAIN CIRCUIT BOARD.....	21
1. Electronic Calibration (Circuit Only).....	21
2. Calibration Using Standard Solution.....	21
3. Transfer Standard Method	22
C. PREVENTIVE CARE.....	22

TABLE OF CONTENTS Continued

SECTION	PAGE
VI. OPTIONS & ACCESSORIES	23
A. OPTIONS ORDERED WITH CTCII.....	23
B. OPTIONS & ACCESSORIES ORDERED SEPARATELY	23
C. STANDARD SOLUTIONS.....	24
VII. REPLACEMENT PARTS	25
VIII. WARRANTY	26
IX. GLOSSARY	27
X. NOTES	28
XI. ADDENDUM	29
A. CONDUCTIVITY, TDS AND TEMPERATURE RELATIONSHIPS.....	29

I. INTRODUCTION

Thank you for selecting one of the Myron L Company's latest Chemical Treatment Controllers. The CTCII is based on input from 'you' - our customers, time proven designs, and many years of instrumentation experience.

Since 1957, the Myron L Company has been providing customers with quality products at an affordable price by designing and producing products that are Accurate, Reliable, and Simple to use. Quality you have come to rely and depend on.

As you read through this operation manual you will see the CTCII is truly designed to be user friendly and simple to install.

The CTCII is packaged as a complete set ready to install which includes the sensor, input power cord (115VAC) and two (2) output connectors (115VAC) in a fully waterproof enclosure.

A. SCOPE

This operation manual provides the user with the necessary information to install, operate and maintain your Myron L Company CTCII Chemical Treatment Controller.

Section I. Provides Descriptions, Applications, Specifications.
Section II. Installation; mounting, wiring and set up.
Section III. Options and Accessory installation procedures.
Section IV. Operating procedures.
Section V. Identifies their primary components and provides the user with easy-to-use calibration and preventive care procedures.
Section VI. Options & Accessories List.
Section VII. Replacement Components.
Section VIII. Warranty information.
Section IX. Glossary, definitions.
Section X. Notes.
Section XI. Addendum.

1. FUNCTIONAL DESCRIPTIONS

All models feature a water proof & corrosion resistant IP65/NEMA 4X enclosure for bench or surface mounting. The CTCII is a compact 4.7" (120mm) x 6.3" (160mm).

Bright dual GREEN/RED LED indicates ON/OFF (above or below set point). All models feature TWO heavy-duty 10 amp output relays, operating on increasing concentrations.

All models include input power cord* (115 VAC powercord 8 ft. with USA 3 prong plug - **NOT** for use with 230 VAC), two (2) output power connectors, CSAR sensor, and appropriate strain reliefs.

The CS51R sensor for more demanding applications may be substituted at an additional cost.

For specific CTCII configurations, reference the following individual model descriptions.

*NOTE: for 230 VAC or other power requirements the plug must be cut off or removed and hard wired directly to the source or a local plug or adapter may be installed.

Model CTCII Chemical Treatment Controller

0-5000 $\mu\text{S}(\mu\text{M})$ / ppm TDS 442™ Controller. Front panel is equipped with a "SET POINT" control and RED/GREEN indicator LED.

Model CTCIIT Chemical Treatment Controller

0-5000 $\mu\text{S}(\mu\text{M})$ / ppm TDS 442™ Controller. Front panel is equipped with a "SET POINT" control and RED/GREEN indicator

LED. A 120 minute Limit Timer is provided to stop the feed pump from continuing to pump chemical(s) in to tower, tank or system. A bright YELLOW LED indicates when Limit Timer is on.

Model CTCIID Chemical Treatment Controller

0-5000 $\mu\text{S}(\mu\text{M})$ / ppm TDS 442™ **Monitor**/controller (value displayed as X.XX mS(mM) or ppt w/ standard LCD). Front panel is equipped with a "SET POINT" control, RED/GREEN indicator LED, and a 3 1/2 digit liquid crystal display (LCD)*.

Model CTCIITD Chemical Treatment Controller

0-5000 $\mu\text{S}(\mu\text{M})$ / ppm TDS 442™ **Monitor**/controller (value displayed as X.XX mS(mM) or ppt w/ standard LCD). Front panel is equipped with a "SET POINT" control, RED/GREEN indicator LED, and a 3 1/2 digit liquid crystal display (LCD)*. A 120 minute Limit Timer is provided to stop the feed pump from continuing to pump chemical(s) in to tower, tank or system. A bright YELLOW LED indicates when Limit Timer is on.

* A 35BL (3 1/2 digit) backlit, or a 45BL (4 1/2 digit) backlit display is available as an option for a full 0-5000 $\mu\text{S}(\mu\text{M})$ or ppm displayed value.

2. APPLICATIONS

Chemical Treatment
Cooling Towers
Process Control
Wastewater Treatment
Food Processing
Plating
Power Plants
Laboratories
Printing
Boiler
Agriculture/Aquaculture
Are just a few of the applications

B. SPECIFICATIONS

RANGE:

0-5000 $\mu\text{S}(\mu\text{M})$ or ppm TDS 442™ (user selectable)

DISPLAY:

Models CTCIID & CTCIITD:

1/2" (13mm) 3 1/2 digit LCD

Displayed value — 0-5.00 mS(mM) or ppt.

NOTE: 3 1/2 digit LCD may be replaced with either a 3 1/2 or a 4 1/2 digit back lit LCD - available as options.

4 1/2 digit displayed value — 0-5000 $\mu\text{S}(\mu\text{M})$ or ppm.

ACCURACY

All Models: $\pm 2\%$ of Full Scale

SENSITIVITY

0.05% of span

STABILITY

0.05% of span

REPEATABILITY

0.1% of span

CALIBRATION CHECK

Built in Electronic Calibration (EC) Mid scale 2500/2.50.

RECORDER OUTPUT

0-10 VDC @ 5 mA max. (linear); standard on all models

OUTPUT IMPEDANCE

100Ω ±5%

SENSOR INPUT

1 (sensor included)

CONTROL FUNCTION

ALL Models:

Single set point alarm/control continuously adjustable
0-100% of span

Hysteresis

Adjustable from 0.3-6% of full scale

Indicators

“HIGH” (red) and “LOW” (green) set point LED.

Relay Contact Rating X 2

SPDT 10 amp @ 115 VAC, 30 VDC. Relay operates on
increasing reading.

Fused Outputs (2)

5 amp @ 115/230 VAC.

INPUT POWER SPECIFICATIONS

115/230 VAC ±15%, 50/60 Hz (User selectable) overvoltage
category II

100 mA Maximum Current

Double Insulated

Fuse - 100mA Slow Blow (T.10A) for both 115 & 230 VAC

(V~) User replaceable

Humidity - 20-90% non-condensing

Max. Altitude -

40,000 ft/12,000 meters non-operating

10,000 ft/3000 meters operating

Pollution degree 2

24 VAC Option available on Special Order

Overvoltage category II

250 mA Maximum Current

Double Insulated

Fuse - 250mA Slow Blow (T.25A) User replaceable

24 VDC Option available on Special Order

250 mA Maximum Current

Double Insulated

Fuse - 250mA Slow Blow (T.25A) User replaceable

AMBIENT TEMPERATURE RANGE

32°F (0°C) to 140°F (60°C)

DIMENSIONS

4.7" (120mm) H x 6.3" (160mm) W x 3.6" (92mm) D

HOUSING CONSTRUCTION

Fully gasketed heavy-duty ABS waterproof and corrosion
proof.

Rated IP65/NEMA 4X

Double Insulated



WEIGHT

CTCII: average 2 lbs. (0.9 kg)

C. OPTIONAL FEATURES

-45 4 1/2 digit backlit liquid crystal display (LCD)

-35BL 3 1/2 digit backlit LCD

-24V 24 VAC isolated power supply (special order)

-24VD 24 VDC isolated power supply (special order)

-C4A 4-20 mA Output Module

-CS51R More Rugged Sensor (replaces the CSAR)

D. OPTIONS & ACCESSORIES

(ordered separately)

45O 4 1/2 digit backlit liquid crystal display (LCD)

35BLO 3 1/2 digit backlit LCD

C4AO 4-20 mA Output Module

LTMO Limit Timer Module Kit

442-3000 Calibration Solution (3000 ppm / 3900 μM/μS)

E. SENSORS

1. CONDUCTIVITY/TDS

CTCII Conductivity/TDS Chemical Treatment Controllers come standard with the **CSAR**. The **CSAR** is of one piece molded construction with two 316 stainless steel pins (electrodes). Standard 3/4" NPT installation. It is rated for applications that do not exceed 75PSI@60°C.

Other sensors for more demanding applications maybe substituted at an additional cost. All sensors include temperature sensor for automatic temperature compensation.

The **CS51R** models compact size allows mounting in a standard 3/4" NPT tee. The sturdy polypropylene bushing is modular for easy, inexpensive replacement. It is rated for applications that do not exceed 100PSI@100°C. Add **-CS51R** to order number if desired.

Special order High Temperature, High Pressure sensors. For detailed descriptions of these and other sensors, see Sensor Selection Guide and specific sensor data sheets available from your local distributor, the Myron L Company, or on line at www.myronl.com.

a. SENSOR SPECIFICATIONS

TEMPERATURE COMPENSATION

Automatic to 25°C, between 32-212°F (0-100°C)
except high temperature models - up to 205°C.

PRESSURE/TEMPERATURE LIMITS

CSAR - 75PSI (517.2 kPa) at 60°C (140°F)
CS51R - 100 psi (689.6 kPa) at 212°F (100°C)
For higher limits, see Special Order Models below.

FITTING/BUSHING

CSAR: 3/4" MNPT threaded ABS body
CS51R: Modular Polypropylene threaded 3/4" NPT

CABLE

Shielded; 10' (3 meters) standard.
25' (7 meters), and
100' (30 meters) lengths also available.

DIMENSIONS

CSAR: 3/4 MNPT. Electrodes, Twin Pin ~3/4 (20mm) L.
CS51R: 3/4 MNPT. Electrode 1.2" (30mm) L; 0.5" (13mm) Dia.

For additional information see sensor selection & specific data sheets for details.

b. SENSOR OPTIONS

-25 25' Shielded Cable
-100 100' Shielded Cable

CS51R Only

-T Titanium - in place of Stainless Steel
-STF Sanitec Fitting.
1/2" thru 4". State size, i.e. STF-1/2.
-PV 1/2" PVDF fitting.
{replaces polypropylene}
-HPSS 1/2" 316 STAINLESS STEEL fitting
(replaces polypropylene).

c. SPECIAL ORDER MODELS — 316 Stainless Steel

(1.0 cell constant)

CS40R Conductivity/TDS Valve Insertable 100PSI@150°C
CS40HTR Above High Temperature Model 250PSI@205°C
CS41R Cond/TDS High Temperature Model 100PSI@150°C

CS41HTR Cond/TDS High Temperature Model 250PSI@205°C
For additional information see sensor selection & specific data sheets for details.

F. ORDERING INFORMATION

Follow steps 1, 2 & 3.

NOTE: CTCII model number includes the CSAR sensor as standard. If other than the CSAR sensor is desired, please specify when ordering.

1. HOW TO ORDER CTCII

Specify Model:

CTCII	—	Basic controller
CTCIID	—	w/ LCD
CTCIIT	—	w/ Limit Timer
CTCIITD	—	w/ Limit Timer and LCD

EXAMPLE A — a basic CTCII controller with a 4-20 mA output.

:
MODEL OPTION
CTCII — C4A

Written as — CTCII-C4A

EXAMPLE B — a CTCIID controller with a 3 1/2 digit digital display, a 4-20 mA output, and a CS51R sensor. The CS51R sensor is for more demanding applications at a modest price increase.

MODEL	OPTION	
CTCIID	— C4A	— CS51R

Written as — CTCIID-C4A-CS51R

2. HOW TO ORDER SPECIAL SENSOR or Sensor Options

Select Special sensor and/or add options to sensor as in examples below.

EXAMPLE C — a model CS51R sensor made with Titanium and a 100 foot cable.

MODEL	OPTIONS
-CS51R	— T-100

Written as — CS51R-T-100

EXAMPLE D — a Special Order High Temperature sensor made of Titanium, and a Wet-Tap Valve.

MODEL	OPTIONS
-CS40HTR	— T-WTV

Written as — -CS40R-T-WTV

3. COMBINING CTCII and SPECIAL SENSOR

Add Steps 1 & 2.

EXAMPLE — Add above examples B and C. A CTCIID controller with a 3 1/2 digit digital display, a 4-20 mA output, and a CS51R sensor made with Titanium and a 100 foot cable.

Written as — CTCIID-C4A-CS51R-T-100

II. INSTALLATION

A. GENERAL

This section provides the recommended procedures for properly installing your CTC Series II Chemical Treatment Controller, and sensors.



CAUTION - READ FOLLOWING CAREFULLY

WARNING: THE MYRON L COMPANY RECOMMENDS THAT ALL MOUNTING AND ELECTRICAL INSTALLATIONS BE PERFORMED BY QUALIFIED PERSONNEL ONLY. FAILURE TO DO SO COULD CAUSE DAMAGE TO INSTRUMENT, AND COULD BE HARMFUL OR FATAL TO PERSONNEL.

B. MECHANICAL INSTALLATION

All CTCII electronics are packaged inside a waterproof/weather-proof enclosure.
The enclosure is designed for surface mounting.

There are four basic guidelines to consider when selecting a mounting location:

1. Select a site that limits the CTCII exposure to excessive moisture and corrosive fumes (water flowing or dripping directly on the power cords may cause an unsafe condition, and is NOT recommended).
2. For best results, position your CTCII controller and sensor as close as possible to the point being controlled. The CTCII controllers are not designed to operate with a sensor cable length that exceeds 100' (30 meters).
3. Mount your CTCII controller at eye level for viewing convenience.

1. SURFACE MOUNTING

NOTE: Due to the many variables of installations mounting screws are not supplied. It is recommended that suitable #6 (M4) screws for the exact conditions be used, i.e. woodscrews, metal or sheetmetal.

1. Select mounting site location.
2. Mark and drill the required mounting holes. For hole drilling locations, see figure II.B.1.
3. Hold the CTCII in place while starting and tightening the mounting screws.



DOUBLE INSULATED

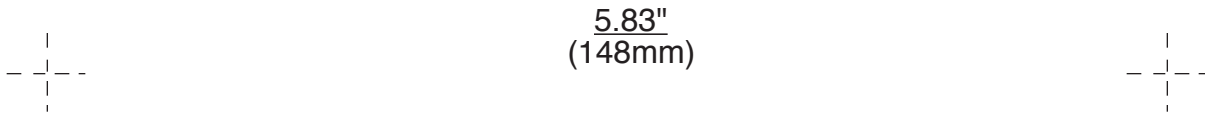

5.83"
(148mm)

SURFACE MOUNTING DIAGRAM

Figure II.B.1.

3.54"
(90mm)

**DIMENSIONS IN INCHES
(MILLIMETERS)**

C. SENSOR INSERTION/IMMERSION MOUNTING

The Sensor's mounting orientation must provide a continuous and adequate circulation flow to prevent the trapping of air bubbles within the Sensor's electrode area (CSAR shown in figure II.D.1). Failure to do so will result in conditions that may prevent the Sensor from functioning properly. The CSAR sensor is designed for insertion (in-line installation). The optional CS51R sensor may be ordered and installed as either insertion, or immersion (see figure II.D.2).

1. INSERTION MODE (in-line installation)

Use approved sealant, i.e. Teflon tape as required.

1. Pre-wind CSAR sensor before installation. Rotate sensor counter clockwise (CCW) (as if removing sensor) 4-5 turns before installing into fitting.
2. Insert the Sensor Fitting assembly into the "T" fitting with electrode aligned with direction of flow as shown in figure II.D.1. and tightly secure. Note: The CS51R installs in the same manner. (but does not require any turns)

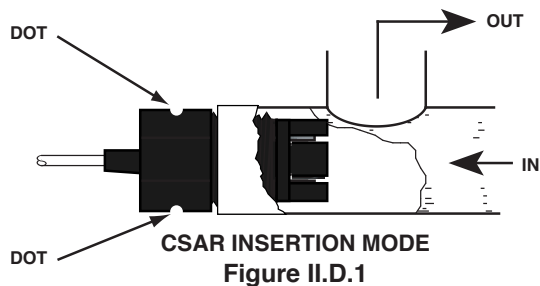

2. IMMERSION OR DIP SENSOR ASSEMBLY

Use approved sealant, i.e. Teflon tape as required.

1. Verify that the CS51R Sensor's Fitting assembly is properly assembled as shown in figure II.D.2.
2. Insert and pull the Sensor's cable through the extension tube and then tightly attach extension tube to Sensor assembly as shown in figure II.D.2.

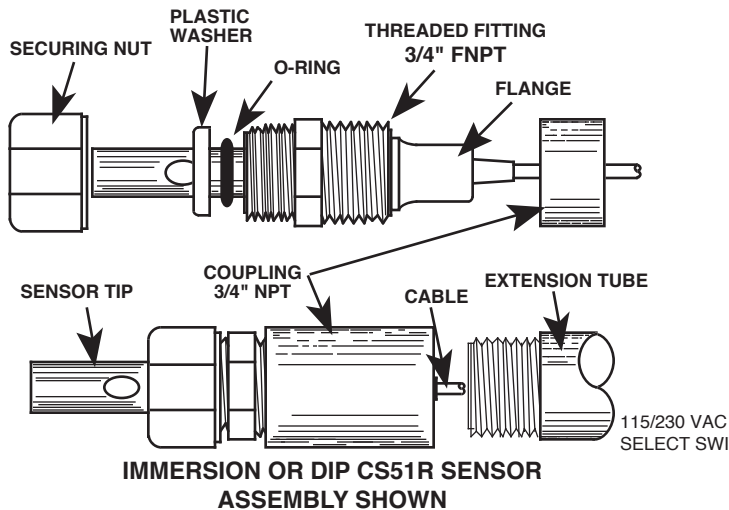

Figure II.D.2

D. ELECTRICAL INSTALLATION

As shipped from the factory, the input power cable, the two (2) output connectors, and the sensor are pre-wired to the controller. Electrical connection simply requires plugging in the appropriate valve and pump, and input power as labeled.



A device to disconnect the Model CTCII from the power supply is required. It is recommended that this switch or circuit breaker be labeled as the disconnection device for the Model CTCII.

WARNING: All CTCII controllers are factory set for 115 VAC. Before starting, ensure the input power "115/230" selection is correct for your requirements. Failure to do so is beyond the responsibility of the Myron L Company. See section II.D.1. below and figure II.E.1.

NOTE: Some models, if ordered, have either a 24 VAC or a 24 VDC input power requirement - check labels carefully.

The following instructions are if the input power, output power or sensor cables are removed.

The electrical installation procedures provided in this manual are common to all CTCII controllers. Unless otherwise instructed, refer to figure II.E.1. for the CTCII controller's terminal block connector wiring designations.

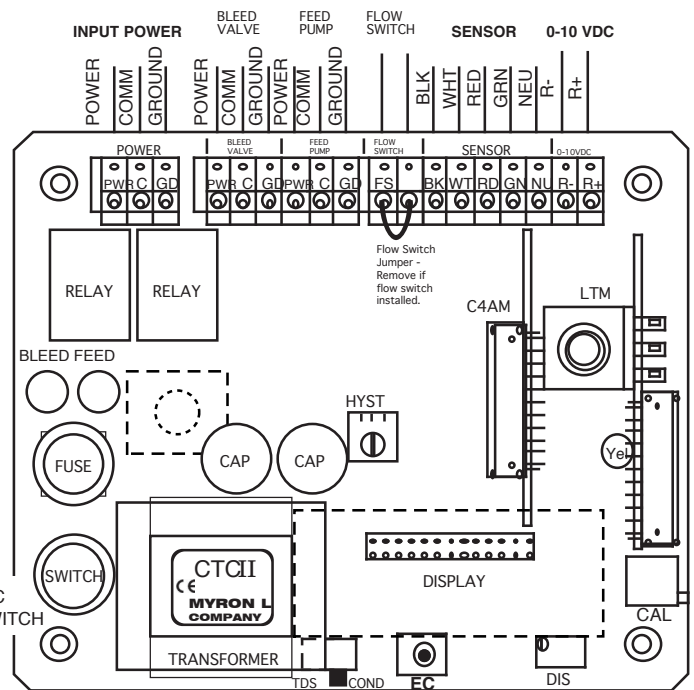

ELECTRICAL CONNECT DIAGRAM

Figure II.E.1

1. 115/230 VAC CONVERSION

1. Before turning power on to the CTCII controller ensure the proper input voltage has been selected. Failure to do so will blow the fuse. It could, under some conditions, cause injury and damage the instrument voiding the warranty.
2. Locate switch located next to the fuse holder.
3. Using a screwdriver, turn switch to required voltage.

2. CONNECTING THE SENSOR CABLE

If the sensor has been removed or requires replacement for any reason.

1. Place the Sensor's interface cable through the supplied watertight cable restraint into the enclosure's appropriate access hole.
2. Install the sensor cable wire to comply with local electrical codes*. Follow the color code as marked. See figure II.E.1.

a. MODIFICATION FOR US PHARMACEUTICAL 25 (No Temperature Compensation)

This simple modification will allow your CTCII Chemical Treatment Controller to meet USP 25 requirements by defeating the normal temperature compensation circuit thus giving "uncompensated" readings as required. Rarely will this be required in the normal applications of this type of controller. However, if it becomes necessary, the following will step you through it.

Specifications:

As required to meet USP 25.

Installation

Briefly -

A resistor is installed in place of the sensor "temperature" sensing leads.

The extra sensor leads are either cut off or the ends are wrapped in tape to prevent shorting.



CAUTION - READ FOLLOWING CAREFULLY

WARNING: BEFORE STARTING, IF CTCII CONTROLLER IS INSTALLED, ENSURE THE POWER IS OFF. FAILURE TO DO SO COULD CAUSE DAMAGE TO THE INSTRUMENT, AND COULD BE HARMFUL OR FATAL TO PERSONNEL. ONLY QUALIFIED PERSONNEL SHOULD INSTALL OR SERVICE ELECTRICAL EQUIPMENT.

Requirements:

One 1.1kΩ .1% resistor, user supplied or may be ordered from the Myron L Company.

NOTE: When opening instrument, remove front panel with care.

1. Using a Phillips Head screwdriver remove the four (4) screws on the clear cover.
2. Remove clear cover.
3. The front panel is held in place with hook & loop strips on each side. By carefully lifting at the slot on the top, the front panel will pull toward you. Do not pull more than about 8 inches/20CM.

DO NOT pull on control knob(s).

4. Rotate the front panel down so that the back side is facing you. The Circuit Board is mounted to the back of the front panel.

5. If sensor is installed, locate and remove the RED (RD) and the GREEN (GN) leads from MAIN Circuit Board, as shown in figure II.E.2.
6. Cut off or tape RED (RD) and the GREEN (GN) leads from sensor.
7. Install 1.1kΩ resistor at RED (RD) and the GREEN (GN) connector locations, as shown in figure II.E.3.
8. Carefully reinstall the front panel.
9. Reinstall the clear cover
10. Reinstall the four (4) screws and tighten.
11. To operate, turn power **ON**.

NOTE: Recalibration will require both the solution and sensor be at 25°C for maximum accuracy.

3. FLOW SWITCH

A flow switch may be installed (electrically connected) utilizing the FS connection*, see figure II.E.1, remove jumper and connect flow switch leads to terminals.

***CAUTION:** The connectors require only a small screwdriver or a pen to push on the release levers. The release levers may be broken or damaged if not pushed straight toward the circuit board. DO NOT push the release levers sideways.

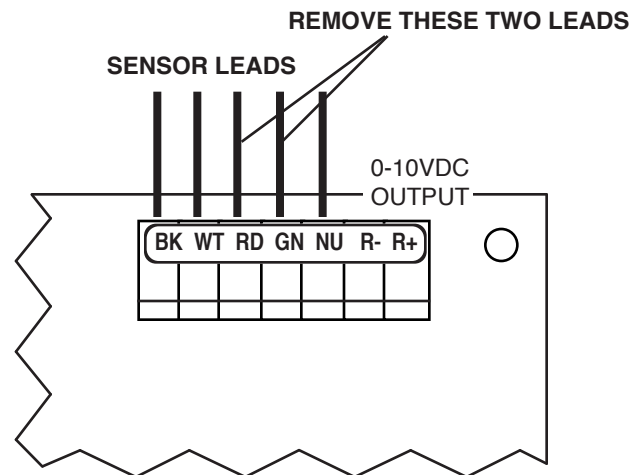

Main CB Assembly
Figure II.E.2

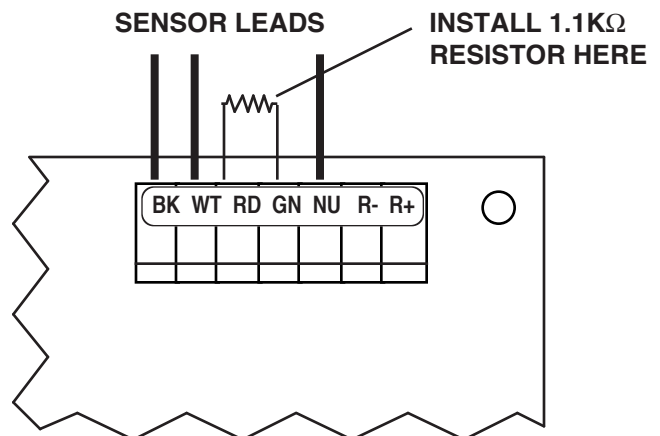

Main CB Assembly
Figure II.E.3

E. 0-10 VDC RECORDER OUTPUT

The 0-10 VDC output is designed to give the user the capability of sending a signal to a remote meter, recorder, PLC or SCADA system.

Requirements

A hole of the proper size must be drilled in the enclosure. The user/installer must choose a location that will NOT interfere with normal operation. To ensure waterproof integrity, a watertight cable restraint must be used. Failure to do so or improper installation will void the warranty and may be costly to repair.

1. CONNECTION

1. Drill appropriate size hole.
2. Place the user supplied interface cable and watertight cable restraint into the hole.
3. Connect the Recorder's plus (+) and minus (-) terminal wires to the Recorder output connectors. (See figure II.E.2.)
4. Refer to Section V.B.1.b for the procedures to calibrate the 0-10 VDC voltage output.

2. VOLTAGE DIVIDER

A voltage divider gives the user the ability to scale or tailor the output to a particular need or requirement due to the input of another device, i.e. the output of the Main CB is 0-10V while the input requirement of a particular recording device is 0-5V.

a. INSTALLATION

Briefly—

Two resistors are installed across the 0-10V output. The output is recalibrated to required voltage.

Requirements

Select two (2) resistors as listed;

For 0-5V Output both "A & B" are 2K Resistors.

For 0-1V Output "A" is a 9K resistor and "B" is a 1K resistor.



CAUTION - READ FOLLOWING CAREFULLY

WARNING: BEFORE STARTING, IF MONITOR/CONTROLLER IS INSTALLED, ENSURE THE POWER IS OFF. FAILURE TO DO SO COULD CAUSE DAMAGE TO THE INSTRUMENT, AND COULD BE HARMFUL OR FATAL TO PERSONNEL. ONLY QUALIFIED PERSONNEL SHOULD INSTALL ELECTRICAL EQUIPMENT.

Physical

If the front panel has all ready been removed from the enclosure skip to #3.

1. Using a Phillips Head screwdriver remove the four (4) screws on the clear cover.
2. Remove clear cover.
3. The front panel is held in place with hook & loop strips on each side. By carefully lifting at the slot on the top, the front panel will pull toward you. Do not pull more than about 8 inches/20CM.

DO NOT pull on control knob(s).

4. Rotate the front panel down so that the back side is facing you. The Circuit Board is mounted to the back of the front panel.
5. Solder two selected resistors together as shown in figure II.F.1.

6. Attach leads to recording device as shown in figure II.F.1.
7. Attach resistors to 0-10V Output as shown in figure II.F.2. Ensure resistors and leads DO NOT short to each other or to any part of the CB assembly.
8. Recalibration is required, see Calibration Procedures, section V.B.

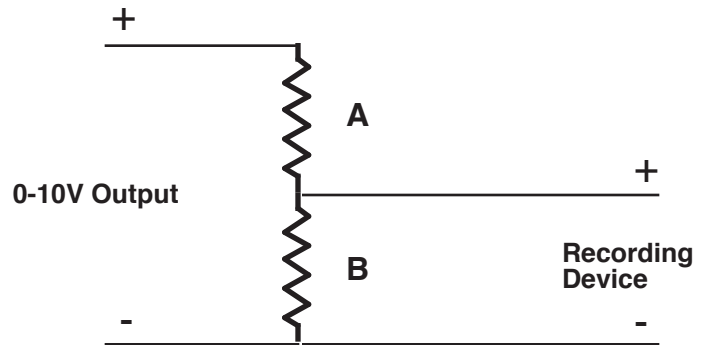
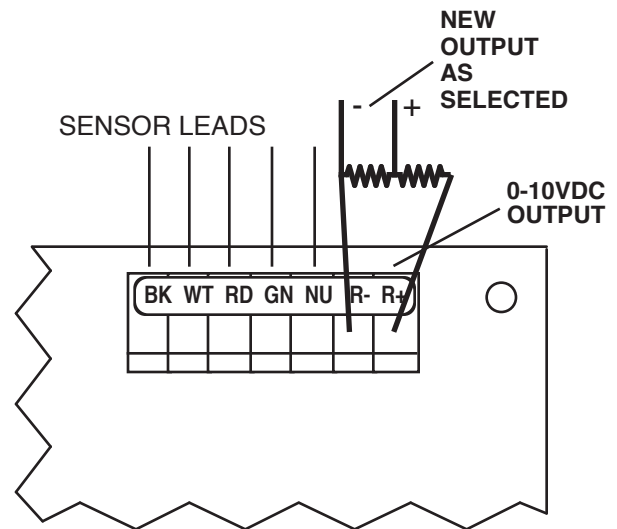

Figure II.F.1



Main CB Assembly

Figure II.F.2

Reassembly

1. Carefully reinstall the front panel, ensure no wires have been pinched.
2. Reinstall the clear cover.
3. Reinstall the four (4) screws and tighten.
4. If desired, install corner covers.
5. To operate, turn power **ON**.

F. RE-SCALE YOUR CTCII CONTROLLER

1. DESCRIPTION

The CTC Series II controller, has been designed for easy field re-scaleability. To re-scale your 0-5000 μS CTCII to 0-5000 "PPM" TDS 442™ or visa versa requires the simple slide of a switch.



CAUTION - READ FOLLOWING CAREFULLY

WARNING: BEFORE STARTING, IF MONITOR/CONTROLLER IS INSTALLED, ENSURE THE POWER IS OFF. FAILURE TO DO SO COULD CAUSE DAMAGE TO THE INSTRUMENT, AND COULD BE HARMFUL OR FATAL TO PERSONNEL. ONLY QUALIFIED PERSONNEL SHOULD INSTALL OR SERVICE ELECTRICAL EQUIPMENT.

Physical

NOTE: When opening instrument, remove front panel with care. If the front panel has already been removed from the enclosure skip to #3.

- Using a Phillips Head screwdriver remove the four (4) screws on the clear cover.
- Remove clear cover.
- The front panel is held in place with hook & loop strips on each side. By carefully lifting at the slot on the top, the front panel will pull toward you. Do not pull more than about 8 inches/20CM.

DO NOT pull on control knob(s).

- Rotate the front panel down so that the back side is facing you. The Circuit Board is mounted to the back of the front panel.
- Locate the switch next to the transformer. See figure II.F.1.
- Slide knob toward the desired scale - TDS/ppm or COND/ μM (μS).
- Recalibrate, see CALIBRATION PROCEDURES, section V.B.
- Install (remove) Parts Per Million - TDS label (supplied inside).
- Reassemble front panel.

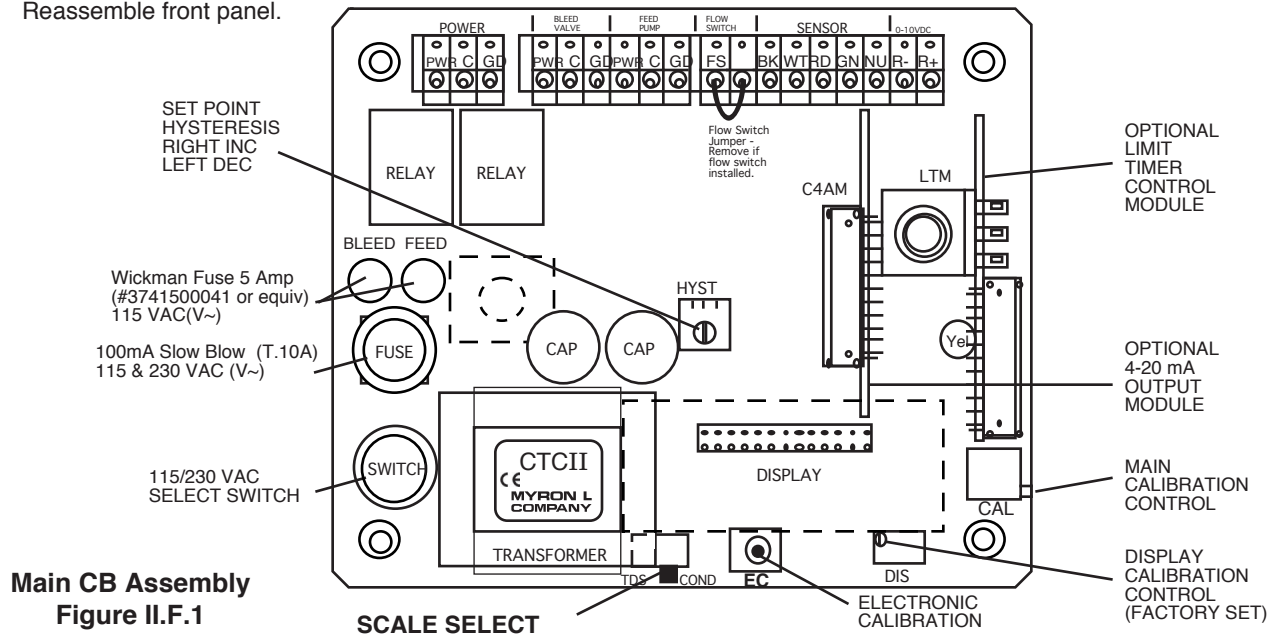

III. OPTIONS & ACCESSORIES

A. LIMIT TIMER MODULE OPTION

LTMO Limit Timer Module Kit ordered separately.

1. DESCRIPTION

This module allows the user to set a "limit" of up to 120 minutes on the length of time the feed pump will operate.

Specifications:

Control Function:

Controls the Feed Pump Relay **only**.

2. INSTALLATION

Briefly -

The Limit Timer Module simply plugs into the CTCII circuit board, see figure III.B.4.

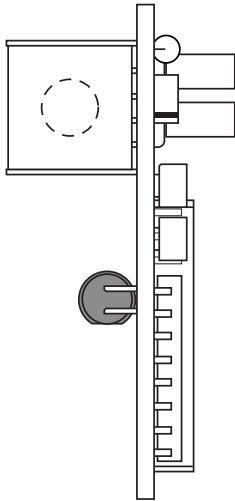

Figure III.A.1



CAUTION - READ FOLLOWING CAREFULLY

WARNING: BEFORE STARTING, IF MONITOR/CONTROLLER IS INSTALLED, ENSURE THE POWER IS OFF. FAILURE TO DO SO COULD CAUSE DAMAGE TO THE INSTRUMENT, AND COULD BE HARMFUL OR FATAL TO PERSONNEL. ONLY QUALIFIED PERSONNEL SHOULD INSTALL OR SERVICE ELECTRICAL EQUIPMENT.

Physical

NOTE: When opening instrument, remove front panel with care. If the front panel has already been removed from the enclosure skip to #3.

1. Using a Phillips Head screwdriver remove the four (4) screws on the clear cover.
2. Remove clear cover.
3. The front panel is held in place with hook & loop strips on each side. By carefully lifting at the slot on the top, the front panel will pull toward you. Do not pull more than about 8 inches/20CM.

DO NOT pull on control knob(s).

4. Rotate the front panel down so that the back side is facing you. The Circuit Board is mounted to the back of the front panel.
5. Carefully press the LT Limit Timer Module into the Circuit Board as shown in figure III.A.4. When fully seated the LTMO option will snap into place.
6. Reassemble front panel.
7. Turn shaft fully counter-clockwise.
8. Install knob on shaft and align to "DOT".
9. Reinstall clear cover.

B. C4A MODULE (4-20 mA OPTION)

-C4A 4-20 mA Self/Remote-powered Isolated output module ordered with controller.

C4AO 4-20 mA Self/Remote-powered Isolated output module ordered separately.

1. DESCRIPTION

The 4-20 mA option gives the CTCII controller the ability to send a signal very long distances with minimal interferences and signal degradation. The output is an Isolated 4-20 mA signal that corresponds to the full scale range of the controller into which it is installed. This output is easily configured to be either self-powered or remote-powered as required for your particular application.

NOTE: The maximum impedance of the user's current input instrument should not exceed 600 ohms.

Since the output is an isolated current loop, it is the ideal choice for applications requiring; a control signal to be run very long distances, systems requiring a 4-20mA input or in instances where isolation is necessary.

As the output is isolated, and a current, it is useful for long distance interface, especially where wiring resistances may be high, and/or the ground potentials may differ between the sensor input ground and the current receiving instruments ground.

The 4-20 mA output will not be degraded in accuracy even when the ground differences are as much as 120 VAC @ 60Hz. Interface wire resistance of 350Ω will not degrade the accuracy of the output when interfaced to a typical 250Ω input impedance of a transmitter current input device.

The output is capable of driving a minimum of 600Ω worst case, therefore, will satisfy virtually all modern interface requirements. Current input devices usually have an input impedance of 250Ω, however, some older designs can have as high as 500Ω or as low as 10Ω. This "-C4A" option will drive any impedance from 0 to 600Ω without any degradation of performance.

There are two modes in which current loop transmitters operate; Self-Powered and Remote-Powered.

Self-Powered — the transmitter provides the power to drive the 4 to 20 mA current. See figure III.B.1.

Remote-powered — the receiving instrument provides the power to drive the 4 to 20 mA current. See figure III.B.2.

Specifications

Self-Powered and Remote-Powered

Drive Impedance — 0 to 600Ω

Common Mode Maximum — 120 VAC @ 60 Hz

Isolation — 100pf max. to Model 750II circuit common
100pf max. to input power line

Calibration

Two multi-turn pots — Factory Set.

4mA = Zero (0)

20mA = 12 mA - Mid Scale

Calibration is NOT required. However, if you feel you must verify or recalibrate, see RECALIBRATION.

DO SO COULD CAUSE DAMAGE TO THE INSTRUMENT, AND COULD BE HARMFUL OR FATAL TO PERSONNEL. ONLY QUALIFIED PERSONNEL SHOULD INSTALL OR SERVICE ELECTRICAL EQUIPMENT.

Physical

- Using a Phillips Head screwdriver remove the four (4) screws on the clear cover.
- Remove clear cover.
- The front panel is held in place with hook & loop strips on each side. By carefully lifting at the slot on the top, the front panel will pull toward you. Do not pull more than about 8 inches/20CM.
DO NOT pull on control knob(s).

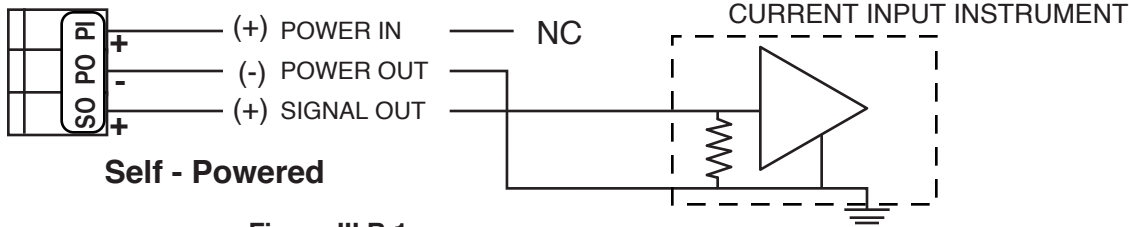

Self - Powered

Figure III.B.1

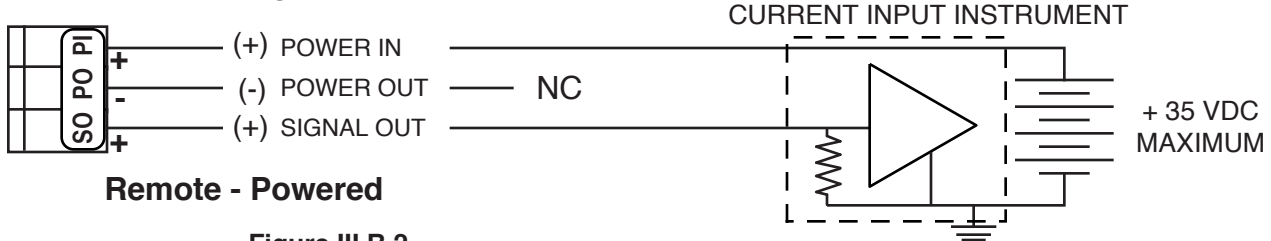

Remote - Powered

Figure III.B.2



Figure III.B.3

- Rotate the front panel down so that the back side is facing you. The Circuit Board is mounted to the back of the front panel.
- Locate the connector on the Circuit Board labeled C4AM.
- Align as shown.
- Press into place. The module will click when fully seated.

Electrical

- Connect the signal and power wires as required, as shown in figures III.B.1. & III.B.2. This assumes you have already connected the other end of the wires as required.
 - Place the remote interface cable and user supplied watertight cable restraint into the enclosure's appropriate access hole.
 - Neatly connect the signal cable wires to the CTC's appropriate connectors as shown in figure III.B.3.
- To test, turn power **ON**.
- Press the EC switch and monitor the output at your remote site, or with a DVM set to DC milliamps. Attach the DVM to the output connectors per your requirements, i.e. self-powered or remote-powered, see figures III.B.1. & III.B. 2. If the C4A module is connected properly it will indicate 12mA.
- Turn power **OFF**.
- Carefully reinstall the front panel.
- Reinstall the clear cover
- Reinstall the four (4) screws and tighten.
- To operate, turn power **ON**.

2. INSTALLATION

Briefly -

The C4A Module simply plugs into the CTCII circuit board, see Figure III.B.4. Connect signal wires per figure III.B.1 or III.B.2.



CAUTION - READ FOLLOWING CAREFULLY

WARNING: BEFORE STARTING, IF MONITOR/CONTROLLER IS INSTALLED, ENSURE THE POWER IS OFF. FAILURE TO

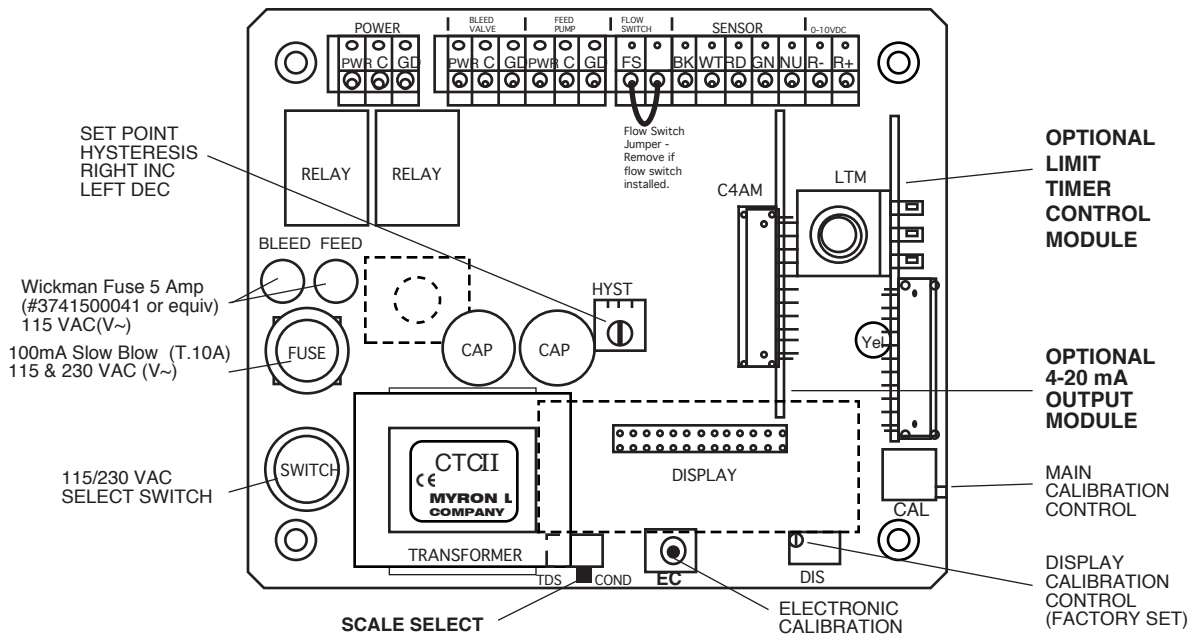

Figure III.B.4.

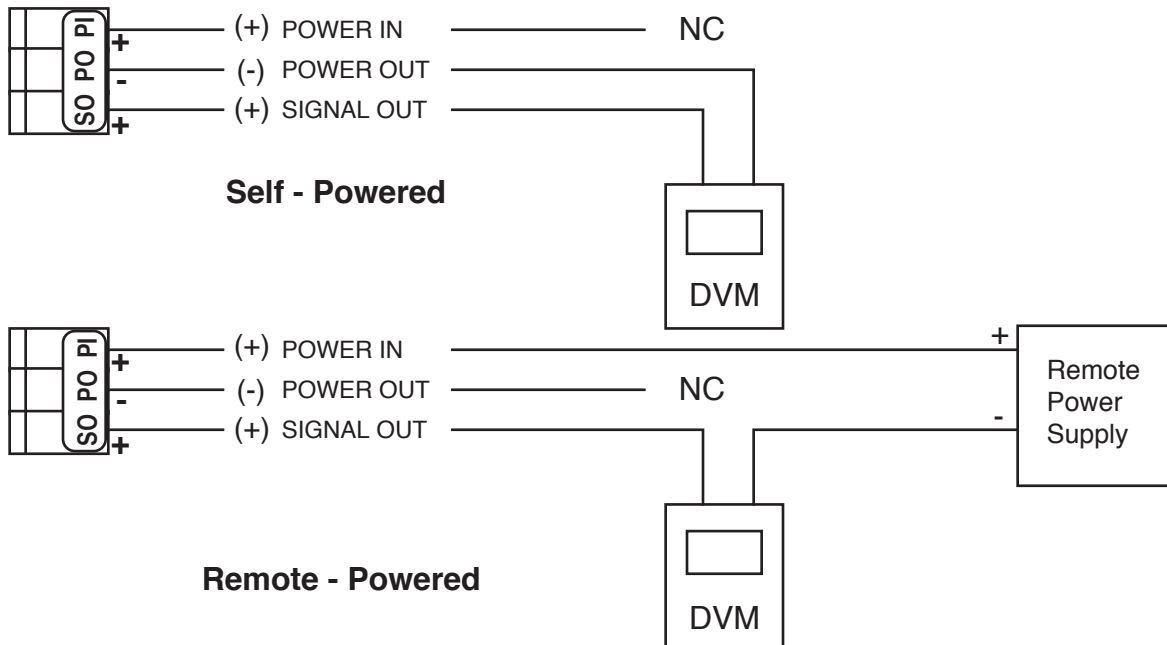

Figure III.B.5.

3. RECALIBRATION

The 4-20 Module was calibrated at the factory, however, if you wish to check the calibration the following procedure will help you to accomplish this task. Exercise caution while performing this procedure.

Requirements; a DVM set to DC milliamps, a tweaker or small standard slot screwdriver.

This procedure assumes the front panel is removed.

1. If sensor is connected, disconnect sensor wires from sensor terminal block.
2. Attach the DVM to the output connectors per your requirements, i.e. self-powered or remote-powered, see figure III.B.5.
3. Turn power **ON**, with the display (if included) at ZERO or

ZERO DC volts out at Recorder, the DVM should indicate 4 mA at the **signal out**.

4. If not, adjust the CAL control marked "**4mA**" until the DVM indicates **4 mA**, see figure III.B.3.
5. Press the EC switch, the DVM should indicate **12 mA**.
6. If not, adjust the CAL control marked "**20mA**" until the DVM indicates **12 mA**. See figure III.B.3.

NOTE: The C4A is linear, calibration at mid scale will not effect the accuracy.

7. Calibration is complete.
8. Turn power **OFF**.
9. Reinstall the clear cover
10. Reinstall the four (4) screws and tighten.
11. To operate, turn power **ON**.

IV. OPERATING PROCEDURES

A. FRONT PANEL INDICATORS & CONTROLS

The front panel illustrations to the right and operational descriptions have been provided to assist the user in identifying and operating their CTCII controller.

Refer to Section IV.B for Setup procedures and Section IV.B.1 for Check-Out procedures.

1. GREEN LED INDICATOR

When the GREEN LED indicator light is ON the conductivity/TDS reading is LOW or BELOW the set point. Controller relays are OFF.

2. RED LED INDICATOR

When the RED LED indicator light is ON the conductivity/TDS reading is HIGH or ABOVE the set point AND the controller relays are ON.

3. SET POINT CONTROL

When the "SET POINT" control is rotated the LED indicator light will change from GREEN to RED and back as the knob is rotated. The relay will switch ON and OFF. See figures IV.A.1 thru 4.

4. DIGITAL DISPLAY MODELS

Digital display provide a continuous readout of the water being controlled.

Models CTCIID & CTCIITD are equipped with a 3 1/2 digit, 1/2" Liquid Crystal Digital Display, as shown in figures IV.A.2 & 4, with a 4 1/2 digit backlit LCD as an option.

5. LIMIT TIMER MODELS

Models CTCIIT & CTCIITD incorporate a Limit Timer for the feed pump. The time may be set up to 120 minutes after which the pump will turn off even though the controller may still be bleeding. While the feed pump Limit Timer is ON a YELLOW LED will turn ON. When the Limit Timer times out the YELLOW LED will turn OFF.

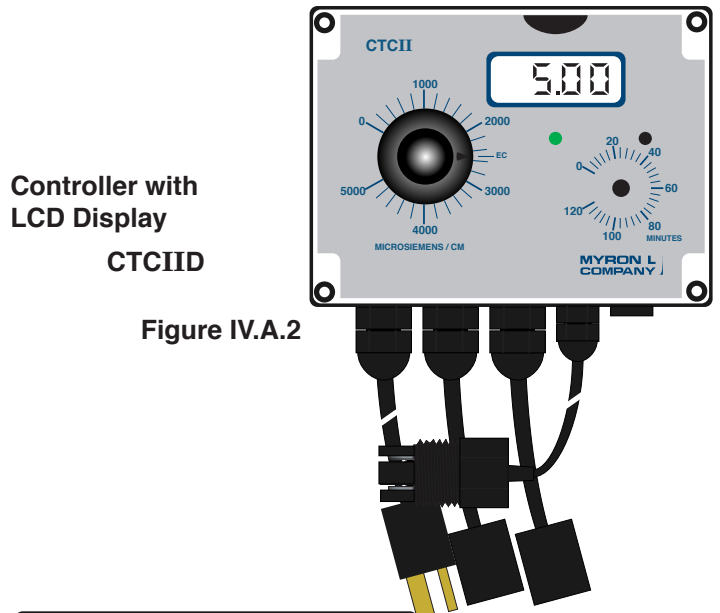

Figure IV.A.2

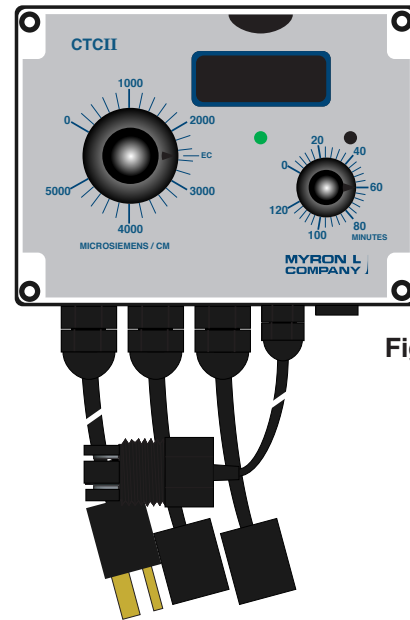

Figure IV.A.3

Controller with Timer
CTCIIT

Basic
Controller

CTCII

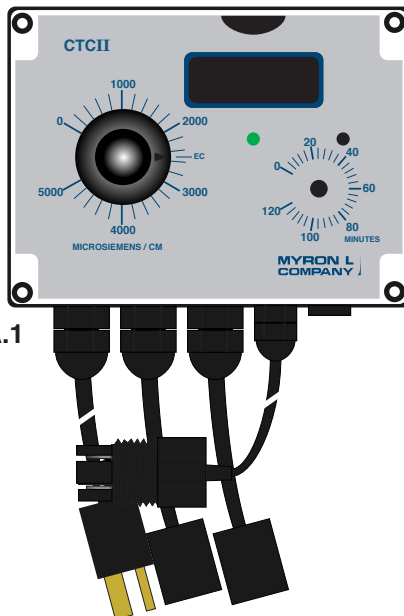
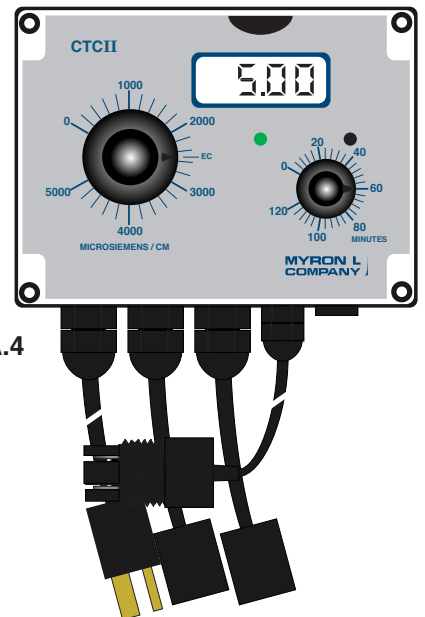

Figure IV.A.1

Controller with LCD
Display and
Timer

CTCIITD

Figure IV.A.4





CAUTION - READ FOLLOWING CAREFULLY

B. SETUP PROCEDURES

These Setup procedures cover (1) checking out your new CTCII Chemical Treatment Controller, (2) setting the control set point, and (3) adjusting the hysteresis.

NOTE: A small screwdriver or tweaker will be required for some of the following operations.

1. CHECK-OUT PROCEDURES

The following check-out procedures are used to verify that the CTCII Controller is operating properly. Refer to figure V.A.1. for the locations of the components referred to in this section.

- a. Assumed that the clear cover and the front panel are removed, the power is ON.
- b. Assumes above PLUS that the controller is connected to an appropriate Sensor, and that the Sensor is immersed in water within the range that the Controller will be required to operate.
- c. Limit Timer check out procedure.

a. Sensor OUT of water.

1. While pressing the Electronic Calibration Switch (EC), rotate the Set Point Control toward "EC" on the dial. Listen for the control relays to click 'ON and OFF' as the set point moves past the EC location. The indicator light (LED) will change from RED to GREEN. If equipped with a display, verify that the display is indicating a reading of approx. 2.50. If not, see Calibration, section V.B.
2. Adjust the Set Point Control to the desired set point value.
3. Reassemble.

b. Sensor IN water.

1. Rotate the Set Point Control on the front panel. The relays will click and the indicator light (LED) will change from RED to GREEN and GREEN to RED as the knob is rotated. As the relays click and the LED changes from RED to GREEN this is the value of the water. Make a note of the reading on the display if so equipped. It will be very close to the value indicated by the set point control knob.
2. Set the Set Point Control to the desired set point value.
3. Reassemble.

c. Limit Timer Check Out Procedure

If the Limit Timer is installed, a YELLOW LED located above the timer knob will also be ON. To test:

1. Rotate the Limit Timer Control on the front panel from its highest position to its lowest position. Only the FEED PUMP relay will click OFF (the YELLOW indicator light will turn OFF).
2. Adjust the Limit Timer to the desired time.

2. SET POINT ADJUSTMENT

The set point setting is based upon the user's particular water purity specifications or requirements. Remove clear cover and adjust control knob to desired set point value.

3. HYSTERESIS (DEAD BAND) ADJUSTMENT

The hysteresis or dead band is approximately $\pm 6\%$ of the set

point at full scale as it leaves the factory. Under normal (most) conditions it will not be necessary to adjust.

However, if you desire to make an adjustment please keep the following in mind.

The adjustment is very simple and is based on set point location. If the set point is in the upper 75-100% of the scale, the hysteresis control pot should be turned fully to the right.

If the set point is in the lower portion of the scale, i.e. 5-25% of scale, the control pot may be turned fully to the left.

If you are operating in the center, 25-75% of scale, the control pot may be adjusted in the center.

Or the hysteresis or dead band may be adjusted to tighten the control of a particular process.

CAUTION: Adjusting the hysteresis too narrow may cause the controller to fluctuate (on-off) due to flow, chemical mixing or bubbles causing the relay to chatter. This condition is to be avoided, it could damage your valves, pumps, etc. and will eventually damage the relay.

The following is assuming the front panel is already removed and the set point has been set, if not see "Set Point Adjustment".

1. Turn power **ON**.
2. Locate the Hysteresis Control (HYST) - it is a single turn pot. See figure V.A.1.
3. Adjust as described in "Hysteresis (Dead Band) Adjustment" or as desired.
4. Rotate set point control on the front panel to verify Hysteresis is set as desired.
5. Turn power **OFF**.

4. "FEED PUMP" LIMIT TIMER

If installed, adjust timer control knob as desired, to limit the ON time of the feed pump.

REASSEMBLY

1. Carefully reinstall the front panel.
2. Reinstall the clear cover.
3. Reinstall the four (4) screws and tighten.
4. To operate, turn power **ON**.

V. COMPONENT IDENTIFICATION, CALIBRATION AND PREVENTIVE CARE

A. PRIMARY COMPONENT IDENTIFICATION

As identified in Section III, the CTCII Chemical Treatment Controllers main circuit board, controls and indicator lights are mounted directly to the front panel.

Review figure V.A.1 below to familiarize yourself with the Main circuit board assembly. The following diagram has the optional Limit Timer Module and 4-20 mA Output Module installed.

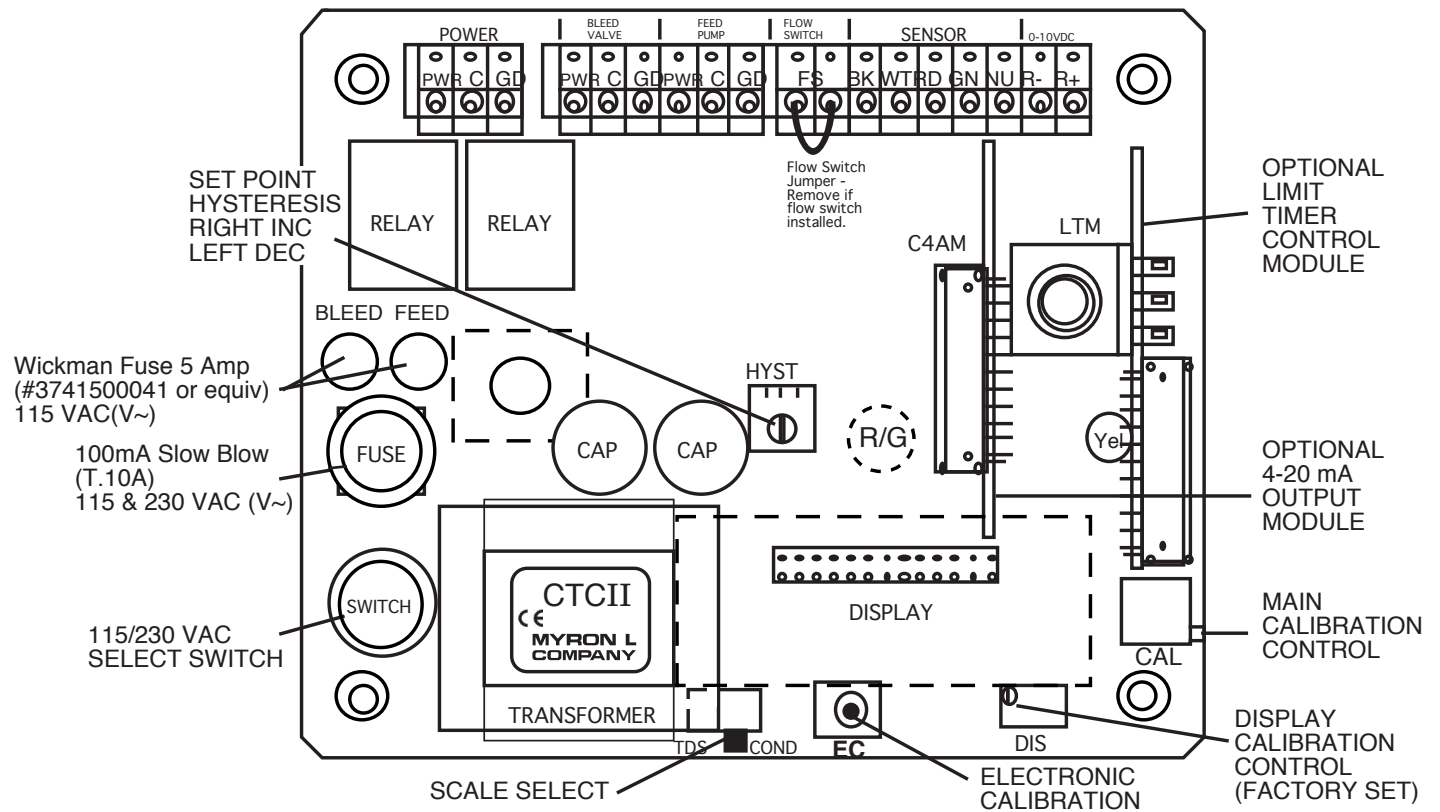

CTCII MAIN CIRCUIT BOARD
Figure V.A.1



CAUTION - READ FOLLOWING CAREFULLY

B. CALIBRATION PROCEDURES

All Myron L CTCII Chemical Treatment Controllers are factory calibrated prior to shipping and are ready to install without further calibration. Calibration should be checked occasionally with the internal Electronic Calibration Test switch (EC) to ensure continued accuracy.

The following procedures are provided in the event that recalibration becomes necessary. The only equipment required are a tweaker or small screwdriver, and standard solution. Refer to Figure V.A.1. to locate the components described in this section.

WARNING: When performing calibration procedures, the technician must take extreme care to avoid contacting the circuitry other than the CALibration control. Failure to do so could result in damage to the equipment, property and/or personal injury.

1. ELECTRONIC CALIBRATION

(CIRCUIT ONLY)

This method is faster than the method using standard solution, but it does not include the sensor. Therefore, it should be used only in applications where the chance of sensor contamination or damage are slight.

The Set Point control will be used to check the calibration.

NOTE: The **DISplay** calibration control (if display is installed) has been **set** and **sealed** prior to leaving the factory, and under normal conditions will not require readjustment. This allows the user to observe the panel display (if installed) to visually set the electronic value. If the **DISplay** calibration control has been adjusted it will be necessary to, first, verify or adjust the Set Point Control Calibration as described in "Set Point Control Calibration" below.

a. Set Point Control Calibration

1. Ensure power is **OFF**.
2. Using a Phillips Head screwdriver remove the four (4) screws on the clear cover.
3. Remove clear cover.
4. The front panel is held in place with hook & loop strips on each side. By carefully lifting at the slot on the top, the front panel will pull toward you. Do not pull more than about 8 inches/20CM.

DO NOT pull on control knob(s).

5. Rotate the front panel down so that the back side is facing you. The Circuit Board is mounted to the back of the front panel.
6. Turn power **ON**.

CAUTION: When handling Circuit Board, DO NOT touch component side. Electrical shock may occur.

7. Press and hold the Electronic Calibration switch (EC).
8. Rotate Set Point Control from "0" toward EC. At EC the relay should click, and the LED should change from RED to GREEN. If not, set Set Point control to EC and adjust the **CALibration** control.
Models with 3 1/2 digit LCD.
The display should indicate 2.50.
If not, adjust the **DISplay** calibration control.
9. Turn power **OFF**.

10. Re-install front panel and cover as described in "REASSEMBLY".
11. To operate, turn power **ON**.

b. 0-10VDC Recorder Output Calibration

For output voltages other than 10VDC, substitute as required, i.e. 5.00VDC or 2.00VDC per Section II.F.2.

Requires a DVM set to DC Volts.

1. Ensure power is **OFF**.
2. Attach DVM to RECORDER output connection.
3. Turn power **ON**.
4. Press and hold the Electronic Calibration switch (EC).
5. The DVM should indicate 5.00VDC.
6. If not, adjust **CALibration** control until DVM indicates 5.00VDC.
7. Verify the set point control is set at EC point. If not, loosen knob on shaft and reset to EC.
8. Verify the display (if installed) is indicating a reading of 2.50. If not, adjust **DISplay** control until a full scale reading is displayed.
9. Turn power **OFF**.
10. Re-install front panel and cover as described in "REASSEMBLY" or continue.
11. To operate, turn power **ON**.

2. CALIBRATION USING STANDARD SOLUTION

The best method of recalibrating your conductivity/TDS CTCII Chemical Treatment Controller is with a NIST traceable Standard Solution (available from the Myron L Company). Because it includes the sensor, the entire system is recalibrated.

The following procedure describes the easiest method for standard solution calibration of your Conductivity/TDS CTCII Chemical Treatment Controller. We recommended using Myron L 442-3000 Standard Solution. This standard solution will calibrate both Conductivity μS (at 3900 μS) and TDS ppm (at 3000 ppm) modes.

1. Rinse thoroughly, and fill a clean glass beaker with the standard solution.
2. Place sensor in the beaker of standard solution. The level of standard solution must be high enough to cover at least 1/2" above the electrodes.
3. Slowly shake the sensor to remove air bubbles from the electrodes.
4. Allow 5-10 minutes for temperature to equilibrate. For the quickest and the best results, both the sensor and solution should be at the same temperature.
5. Turn power **ON**.
6. Rotated the Set Point control to 3900 for Conductivity modes or 3000 for TDS modes. The relay should click and the LED will change from RED to GREEN. Display models (standard 3 1/2 digit).
The display should match the value of the standard solution, 3900 μS (displayed as 3.90) or 3000 ppm (displayed as 3.00).
If the reading is different, adjust **CALibration** control on the main circuit board until the reading matches the solution value.
7. After adjustment, turn power **OFF**.
8. Re-install front panel and cover as described in "REASSEMBLY".
9. To operate, turn power **ON**.

3. TRANSFER STANDARD METHOD

For maximum accuracy of any Monitor/controller, the transfer standard method should be utilized. Instead of removing the entire Monitor/controller and sensor, and either returning it to the manufacture or sending it to a third party laboratory for recertification, the transfer standard allows quick recertification and return to service — less down time. While being the most accurate method it is also very easy to perform, and may be used to calibrate ANY manufacture Monitor/controller — resistivity or conductivity/TDS. This method still has the benefit of third party verification, if so desired.

1. A high quality hand-held instrument, one capable of accurate conductivity/TDS readings such as the Myron L Ultrameter™, is calibrated using a standard solution, or if so desired, sent to a third party laboratory for calibration & certification. Preferably the standard solution should be as close as practicable to the area of the Monitor/controller operation, i.e. for a conductivity Monitor/controller that is operating between 1500 and 2000 μ S, the recommended Myron L standard solution is KCl-1800.
2. Once the Ultrameter is calibrated, the process water is measured.
3. Finally, the Monitor/controller is calibrated/adjusted to match the value measured by the Ultrameter by adjusting the Main **CAL**ibration control shown in figure V.A.1.
4. Turn power **OFF**.
5. Re-install front panel as described below in "REASSEMBLY".

REASSEMBLY

1. Carefully reinstall the front panel.
2. Reinstall the clear cover.
3. Reinstall the four (4) screws and tighten.
4. If so desired, install corner covers.
5. To operate, turn power **ON**.

C. PREVENTIVE CARE

The Myron L Company recommends that the following Preventive Care procedures be observed.

1. Try to prevent exposure to excessive heat and moisture.
2. The main AC power source should be protected against excessive voltage "spikes."
3. Take care not to damage the Monitor or sensor during handling.

NOTE: Daily, weekly or monthly maintenance schedules are based upon the frequency of use and the severity of the CTCII Chemical Treatment Controllers environment and operating conditions.

4. Repeat the Check-Out procedures to verify satisfactory operation and/or isolate possible troubleshooting symptoms.
5. Check all cable connections to ensure that they are free of moisture and contamination.
6. Inspect and replace damaged component boards and cable assemblies.
7. Periodically remove, clean and inspect the Sensor.

CLEANING - clean clear cover with soap and water, and soft non-abrasive cloth.

VI. OPTIONS & ACCESSORIES

A. OPTIONS ORDERED WITH CTCII CONTROLLER

PART #	DESCRIPTION
-C4A	4-20mA Self-Powered Isolated Output Module (Digital & OEM Only)
-45	4 1/2 Digit "Backlit" Liquid Crystal Display (LCD)
-35BL	3 1/2 Digit "Backlit" Liquid Crystal Display (LCD)
-51R	CS51R, 316 SS conductivity sensor w/ 10 ft/3mtr cable (sensor upgrade)

SPECIAL ORDER OPTIONS

-24V	24 VAC Isolated Power
-24VD	24 VDC Isolated Power
-SQC	Quik-connect, sensor cable M/F

* allow approximately three (3) weeks.

B. OPTIONS & ACCESSORIES ORDERED SEPARATELY

PART #	DESCRIPTION
CLTMO	Limit Timer Module w/ small knob (when ordered after initial purchase)
C4AO	4-20mA Self-Powered Isolated Output Module (Digital & OEM Only)
45O	4 1/2 Digit Backlit Liquid Crystal Display (LCD)
35BLO	3 1/2 Digit "Backlit" Liquid Crystal Display (LCD)
VR	Powersupply, 24 VAC, 20VA. (115 VAC - Indoor use Only)
CC	NIST Certificate without Sensor
CCS	NIST Certificate with Sensor in Standard Solution

C. STANDARD SOLUTIONS & BUFFERS

1. CONDUCTIVITY/TDS STANDARD SOLUTIONS

Your CTCII Chemical Treatment Controller has been factory certified to meet certain specifications based on the appropriate Myron L Company NIST traceable standard solution. This same solution is available to you.

442-3000 3900 $\mu\text{S}/\mu\text{M}$ Conductivity and 3000 ppm TDS

Other standard solutions are available to meet your needs or requirements.

DESCRIPTION

The Myron L Company manufactures three basic types of conductivity/TDS standard solutions — KCl, NaCl and 442™. See below.

Most Myron L standard solution bottles show three values referenced at 25°C:

Conductivity in microsiemens/micromhos, while the ppm/TDS equivalents are based on our 442 Natural Water™, and NaCl standards. All standards are within $\pm 1.0\%$ of reference solutions.

These same buffers may be used for calibration and recertification of your Myron L or other handheld instrument.

a. Potassium Chloride (KCl)

The concentrations of these reference solutions are calculated from data in the International Critical Tables, Vol. 6.

b. 442 Natural Water™

442 Natural Water Standard Solutions are based on the following salt proportions: 40% sodium sulfate, 40% sodium bicarbonate, and 20% sodium chloride which represent the three predominant components “anions” in freshwater. This salt ratio has conductivity characteristics approximating fresh natural waters and was developed by the Myron L Company over three decades ago. It is used around the world for measuring both conductivity and TDS in drinking water, ground water, lakes, streams, etc.

c. Sodium Chloride (NaCl)

This is especially useful in sea water mix applications, as sodium chloride is its major salt component. Most Myron L standard solution labels show the ppm NaCl equivalent to the conductivity and to ppm 442 values.

2. pH and ORP BUFFER SOLUTIONS

For your pH and/or ORP Monitor/controller. Your pH and ORP Monitor/controller requires the same care and calibration as your Conductivity/TDS Monitor/controller. With the following Myron L Company NIST traceable buffer solutions it is possible for you to maintain the accuracy required in your process.

NOTE: pH and/or ORP Monitor/controllers ORP ZERO is calibrated using 7pH buffer. SPAN may be calibrated using any high quality ORP mV solution.

These same buffers may be used for calibration and recertification of your Myron L or other handheld instrument.

a. pH Buffer Solutions

pH buffers are available in pH values of 4, 7 and 10. Myron L Company buffer solutions are traceable to NIST certified pH references and are color-coded for instant identification. They are

also mold inhibited and accurate to within ± 0.01 pH units @ 25°C. Order 4, 7 or 10 Buffer.

b. pH Sensor Storage Solution

Myron L Storage Solution prolongs the life of the pH sensor. It is available in quarts and gallons. Order SSQ or SSG.

C.1.a. Potassium Chloride Standards

KCl-18
KCl-180
KCl-1800
KCl-18,000

KCl-70
KCl-700
KCl-7000
KCl-70,000

C.1.b. 442 Natural Water Standards

442-15
442-150
442-1500
442-15,000

442-30
442-300
442-3000
442-30,000

442-500
442-1000

C.1.c. Sodium Chloride Standards

NaCl-12.5
NaCl-13.4
NaCl-14.0

C.2.a. pH Buffer Solutions

pH4.0
pH7.0
pH10.0

C.2.b. pH/ORP Storage Solution

SSQ - Quart/liter
SSG - Gallon

Customer Standard Solutions available by special order @ \$90.00 per Gallon. Contact us with your request.

Order example: 442-3000QT
KCl-7000GAL

VII. REPLACEMENT PARTS

Contact the Myron L Company for the latest prices.

PART # **CONTROLLER MODEL** For Timer Module see below

CTCIICB CTCII Circuit Board Digital controller only
CTCIIDCB CTCII Circuit Board Digital Monitor/controller

For Timer Module see below.

24V 24VAC Isolated Power, add to above prices

24VD 24VDC Isolated Power, add to above prices

If VOLTAGE is not specified, 115/230 VAC will be supplied.

TIMER MODULE

LTMO CTCII Timer Module

DIGITAL DISPLAYS

35O 3 1/2 Digit without Bezel

35BLO 3 1/2 Digit Backlit without Bezel

45O 4 1/2 Digit Backlit without Bezel

ENCLOSURE

CTCIIER CTC series II Rear Enclosure

CTCIIEL CTC series II Clear Lid w/ screws

CTCIIEC CTC series II Complete

FRONT PANEL with Label only

CTCIIFP Front Panel with LCD & Timer Label

OPTIONS & ACCESSORIES

F100 Fuse; 115/230 VAC Control Board, 100mA (T.10A) 5 X 20 Slow Blow/Time Delay

F250 Fuse; 24 VAC Control Board, 250mA (T.25A) 5 X 20 Slow Blow/Time Delay

FUSE5A Fuse; 115/230 (CTCII Relays, 5 amp (Wickman subminiature Fuse P/N 3741500041)

VIII. WARRANTY

Your Myron L Company CTCII Chemical Treatment Controller and sensor have a **TWO-year** limited warranty. If any controller or sensor fails to function normally, return the faulty unit to the factory prepaid. If, in the opinion of the factory, failure was due to materials or workmanship, repair or replacement will be made without charge.

A reasonable service charge will be made for diagnosis or repairs due to normal wear, abuse or tampering. Warranty is limited to the repair or replacement of Monitor/controller or sensor only. The Myron L Company assumes no other responsibility or liability.

MYRON L COMPANY
2450 Impala Drive
Carlsbad, CA 92008-7226 USA
Tel: 760-438-2021
Fax: 760-931-9189

www.myronl.com

ADDITIONAL INFORMATION

Custom Monitors/controllers available, contact us with your special needs. Price and delivery upon request.

ALL SPECIAL ORDER ITEMS ARE NON-RETURNABLE AND NON-REFUNDABLE.

Because of our policy of continuous product improvement, the Myron L Company reserves the right to make changes in design, specifications, and prices without notice.

Minimum order \$25.00. All prices are US dollars and are F.O.B Carlsbad, CA. USA.

Terms: 1% 10 days, net 30 days upon receipt of sufficient credit information.

Export orders: payment in advance, sight draft collection, or credit card.

IX. GLOSSARY

442™	An Internationally recognized “natural water” standard developed by the Myron L Company in 1964.
Algorithm	A procedure for solving a mathematical problem. See Addendum, Temperature Compensation and TDS Derivation.
Anions	Negatively charged ions
DVM	Digital Volt Meter
Hysteresis	Dead Band — related to alarm set point. The amount of delay or overlap between change from high to low or low to high.
LCD	Liquid Crystal Display
KCl	Potassium Chloride — used as a standard for many applications. Normally, micromhos or microsiemens are the units of measure.
NaCl	Sodium Chloride — used as a standard for sea water and other applications.
NIST	National Institute Standards & Testing
PLC	Programmable Logic Controller
PPM	Parts Per Million — common units of measure for TDS.
PPT	Parts Per Thousand — common units of measure for TDS.
SCADA	Supervisory Control And Data Acquisition
Tempco (TC)	Temperature Compensation — See Addendum, Temperature Compensation.
TDS	Total Dissolved Solids, the Total Conductive Ions in a solution — normally displayed as ppm or ppt. See Addendum, Conductivity Conversion to TDS.
Tweaker	A screwdriver specially designed for adjusting electrical calibration controls.
μM or μS	Micromho or microsiemen — common unit of measure for conductivity.
Meg or MΩ	Megohm — common unit of measurement for resistivity.
USP25	United States Pharmaceutical regulation, revision number 25. In part, requires Conductivity/TDS, resistivity or pH measurements be taken, recorded and/or systems controlled using equipment without temperature compensation. Requires a separate temperature measuring device (temperature measurements may be part

of Cond/TDS, Resistivity or pH device but must not actual correct measurements for temperature errors).

X. NOTES

XI. ADDENDUM

XI. ADDENDUM Continued

MYRON L COMPANY
2450 Impala Drive
Carlsbad, CA 92008-7226 USA
Tel: 760-438-2021
Fax: 760-931-9189
Made In USA

www.myronl.com

ACCURACY • RELIABILITY • SIMPLICITY

MYRON L
COMPANY |
Water Quality Instrumentation
Accuracy • Reliability • Simplicity